

Technology for  
**Health**  
Sağlık İçin Teknoloji

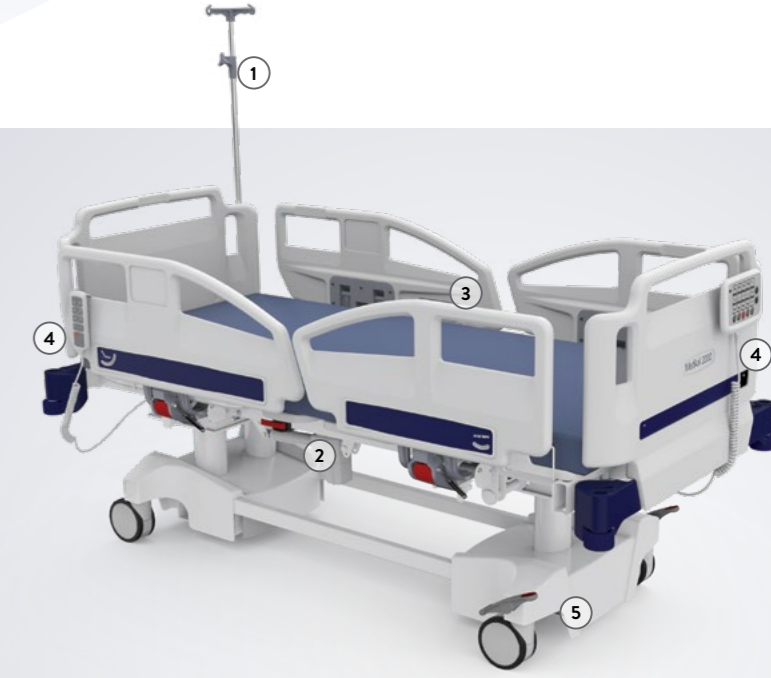



### Genel Özellikler / General Features

- Sessiz çalışma için min.IPX4 korumaya sahip lineer ve kolon motorlar
- El kumandası
- Fonksiyon kilitleme özelliğine sahip hemşire paneli
- Elektronik olarak sırt, ayak, yükseklik, trendelenburg ve ters trendelenburg, lateral tilt hareketi
- Manuel ve Elektronik CPR
- "Polipropilen (PP) malzemeden imal edilmiş yan korkuluklar ve sökülüp takılabilen başucu ve ayakucu panelleri"
- ABS malzemeden imal 4 parçalı yatma yüzeyi
- Diz hareketlerini kademeli mekanizma ile ayarlayabilme
- 360° dönebilen merkezi kilitli tekerler (150 mm)
- Plastik koruyucu çarpma tamponları
- İdrar torbası askılığı
- Aksesuar Yuvaları
- Yüksekliği ayarlanabilir serum askısı
- Nano seramik kaplı elektrostatik toz boyalı metal aksam
- Sırt kayması
- Korkuluklarda aç göstergesi
- 85x190x12cm 28 dansite şilte
- Batarya
- Linear motors with min IPX4 protection for quiet operation
- Remote control
- Nurse panel with function locking feature
- Electrically adjustable back, foot, height, trendelenburg, reverse trendelenburg and tilt (lateral) movements
- Manual and Electronic CPR
- Removable and mountable head and foot boards made of Polypropylene (PP)
- 4-piece lying surface made of ABS material
- Gradually adjustable knee movements
- 360° swivel central brake double castors (150 mm)
- Plastic protective bumpers against impact
- Urine bag holder
- Accessory Slots
- Height adjustable IV Pole
- Nano ceramic coated electrostatic powder painted metal parts
- Backrest Slippage
- Angle indicator on siderails
- 85x190x12 cm 28DNS mattress
- Battery



### Teknik Özellikler / Technical Features

En (Tampon)	Boy (Tampon)	Yükseklik Min.	Yükseklik Max.	Yatma Yüzeyi	Sırt Açısı	Ayak Açısı	Trendelenburg Açısı	Ters Trendelenburg Açısı	Güvenli Taşıma Kapasitesi
Width (Over all)	Lenght (Over all)	Height Min.	Height Max.	Lying Surface	Backrest Angle	Legrest Angle	Trendelenburg Angle	Antitrendelenburg Angle	Safety Working Capacity
103,5 cm	212,5 cm	58,5 cm	98,5 cm	85x190 cm	70°	30°	18°	18°	230 kg

### Opsiyonel Özellikler / Optional Features

- Reklendirilebilir başlık ve korkuluk etiketleri
- X-ray kaset taşıyıcı
- Kilitlenebilen başlıklar
- Dosyalık
- Ayakucu uzatma
- Hpl yatma yüzeyi
- Oksijen tüplük
- 5. Teker
- Defibrilatör sehpa
- Traksiyon seti
- Sticker options in different colours for Head/ Footboards and side rails
- X-Ray cassette holder
- Lockable Headboards and Footboards
- File Holder
- Leg extension part
- HPL lying surface
- Weighing scale
- Oxygen holder
- 5. Casters
- Defibrillator stand
- Traction set

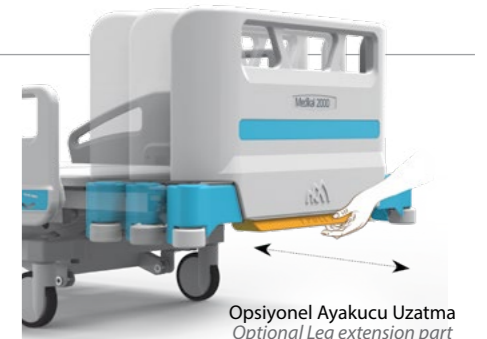



### Genel Özellikler / General Features

- Sessiz çalışma için min IPX4 korumaya sahip lineer motorlar
- El kumandası
- Fonksiyon kilitleme özelliğine sahip hemşire paneli
- Elektronik olarak sırt, ayak, yükseklik, trendelenburg ve ters trendelenburg hareketi
- Manuel ve Elektronik CPR
- Polipropilen (PP) malzemeden imal edilmiş yan korkuluklar ve sökülüp takılabilen başucu ve ayakucu panelleri
- ABS malzemeden imal edilmiş 4 parçalı yatma yüzeyi
- Batarya
- Diz hareketlerini kademeli mekanizma ile ayarlayabilme
- 360° dönebilen merkezi kilitli tekerler (150 mm)
- Plastik koruyucu çarpma tamponları
- İdrar torbası askılığı
- Aksesuar Yuvaları
- Yüksekliği ayarlanabilir serum askısı
- Nano seramik kaplı elektrostatik toz boyalı metal aksam
- Sırt kayması
- Korkuluklarda açılı göstergesi
- 85x190x12 cm 28DNS şilte
- Linear motors with min IPX4 protection for quiet operation
- Remote control
- Nurse panel with function locking feature
- Electrically adjustable back, foot, height, trendelenburg and reverse trendelenburg movements
- Manual and Electronic CPR
- Removable and mountable head and foot boards made of Polypropylene (PP)
- 4-piece lying surface made of ABS material
- Battery
- Gradually adjustable knee movements
- 360° swivel central brake castors (150 mm)
- Plastic protective bumpers against impact
- Accessory Slots
- Height adjustable IV Pole
- Nano ceramic coated electrostatic powder painted metal parts
- Backrest slippage
- Angle indicator on siderails
- 85x190x12 cm 28DNS mattress
- Urine bag holder

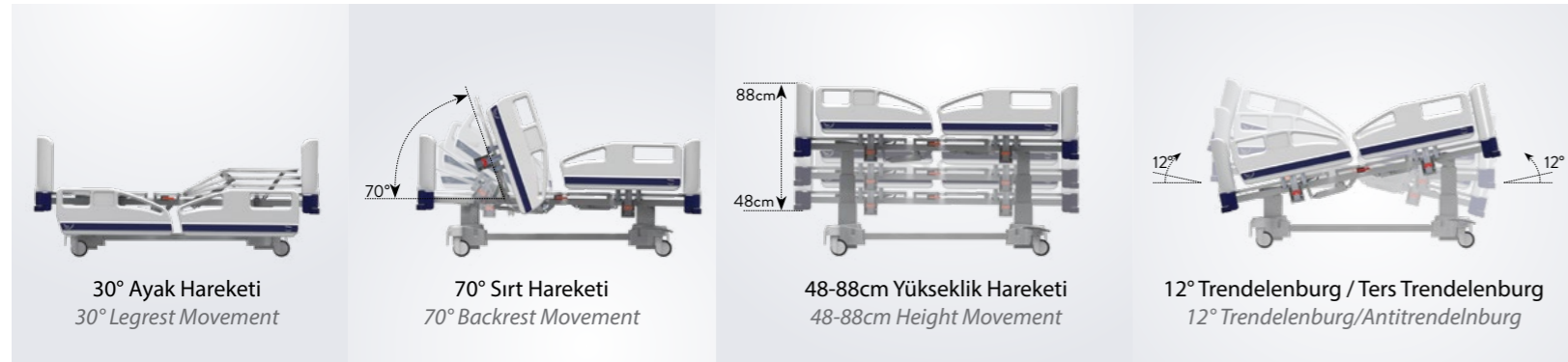

### Teknik Özellikler / Technical Features

En (Tampon)	Boy (Tampon)	Yükseklik Min.	Yükseklik Max.	Yatma Yüzeyi	Sırt Açısı	Ayak Açısı	Trendelenburg Açısı	Ters Trendelenburg Açısı	Güvenli Taşıma Kapasitesi
Width (Over all)	Lenght (Over all)	Height Min.	Height Max.	Lying Surface	Backrest Angle	Legrest Angle	Trendelenburg Angle	Antitrendelenburg Angle	Safety Working Capacity
103,5 cm	212,5 cm	48 cm	88 cm	85x190 cm	70°	30°	12°	12°	230 kg

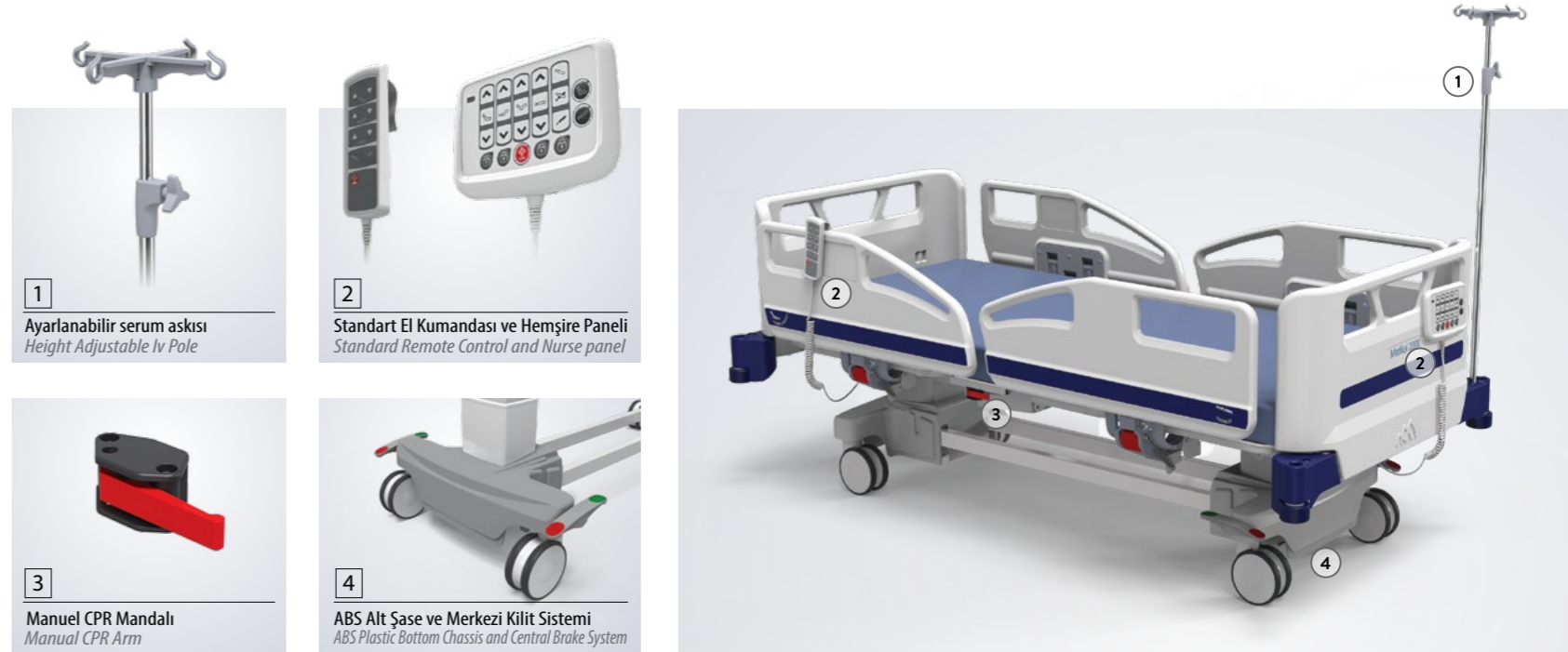

### Opsiyonel Özellikler / Optional Features

- Korkuluk kumanda paneli
- Reklendirilebilir başlık ve korkuluk etiketleri
- X-ray kaset taşıyıcı
- Kilitlenebilen başlıklar
- Yatak altı aydınlatma
- Dosyalık
- Ayakucu uzatma
- Tartı
- Hpl yatma yüzeyi
- Oksijen tüplük
- 5. Teker
- Defibrilatör sehpa
- Traksiyon seti
- Siderails Control Panel
- Sticker options in different colours for Head/Footboards and side rails
- X-Ray cassette holder
- Lockable Headboards and Footboards
- Underbed Light
- File Holder
- Leg extension part
- HPL lying surface
- Weighing scale
- Oxygen holder
- 5. Casters
- Defibrillator stand
- Traction set





### Genel Özellikler / General Features

- Sessiz çalışma için min IPX4 korumaya sahip lineer motorlar
- El kumandası
- Fonksiyon kilitleme özelliğine sahip hemşire paneli
- Elektronik olarak sırt, ayak, yükseklik, trendelenburg ve ters trendelenburg hareketi
- Manuel ve Elektronik CPR
- Polipropilen (PP) malzemeden imal edilmiş yan korkuluklar ve sökülüp takılabilen başucu ve ayakcu panelleri
- ABS malzemeden imal edilmiş 4 parçalı yatma yüzeyi
- Diz hareketlerini kademeli mekanizma ile ayarlayabilme
- 360° dönebilen merkezi kilitleli tekerler (150 mm)
- Plastik koruyucu çarpma tamponları
- İdrar torbası askılığı
- Aksesuar Yuvaları
- Yüksekliği ayarlanabilir serum askısı
- Nano seramik kaplı elektrostatik toz boyalı metal aksam
- Sırt kayması
- Korkuluklarda açılı göstergesi
- 85x190x12 cm 28DNS şilte
- Batarya
- Linear motors with min IPX4 protection for quiet operation
- Remote control
- Nurse panel with function locking feature
- Electrically adjustable back, foot, height, trendelenburg and reverse trendelenburg movements
- Manual and Electronic CPR
- Removable and mountable head and foot boards made of Polypropylene (PP)
- 4-piece lying surface made of ABS material
- Gradually adjustable knee movements
- 360° swivel central brake castors (150 mm)
- Plastic protective bumpers against impact
- Accessory Slots
- Height adjustable IV Pole
- Nano ceramic coated electrostatic powder painted metal parts
- Backrest Slippage
- Angle indicator on siderails
- 85x190x12 cm 28DNS mattress
- Battery

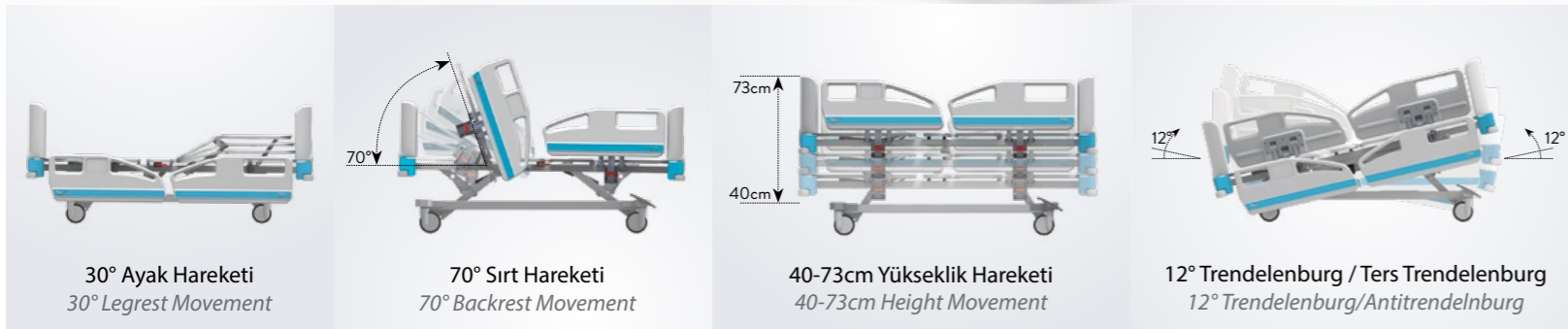

### Teknik Özellikler / Technical Features

En (Tampon)	Boy (Tampon)	Yükseklik Min.	Yükseklik Max.	Yatma Yüzeyi	Sırt Açısı	Ayak Açısı	Trendelenburg Açısı	Ters Trendelenburg Açısı	Güvenli Taşıma Kapasitesi
Width (Over all)	Length (Over all)	Height .Min	Height .Max	Lying Surface	Backrest Angle	Legrest Angle	Trendelenburg Angle	Antitrendelenburg Angle	Safety Working Capacity
103,5 cm	212,5 cm	40 cm	73 cm	85x190 cm	70°	30°	12°	12°	230 kg

### Opsiyonel Özellikler / Optional Features

- Korkuluk kumanda paneli
- Reklendirilebilir başlık ve korkuluk etiketleri
- X-ray kaset taşıyıcı
- Kilitlenebilir başlıklar
- Yatak altı aydınlatma
- Double teker
- Dosyalık
- Ayakcu uzatma
- Hpl yatma yüzeyi
- Oksijen tüplük
- Defibrilatör sehpa
- Traksiyon seti
- Siderails Control Panel
- Sticker options in different colours for Head/Footboards and side rails
- X-Ray cassette holder
- Lockable Headboards and Footboards
- Underbed Light
- Double castors
- File Holder
- Leg extension part
- Hpl lying surface
- Oxygen holder
- Defibrillator stand
- Traction set





### Genel Özellikler / General Features

- Sessiz çalışma için min IPX4 korumaya sahip lineer motorlar
- El kumandası
- Elektronik olarak sırt, ayak ve yükseklik hareketi
- Manuel ve Elektronik CPR
- Manuel trendelenburg hareketi
- Polipropilen (PP) malzemeden imal edilmiş yan korkuluklar ve sökülüp takılabilen başucu ve ayakcu panelleri
- ABS malzemeden imal edilmiş 4 parçalı yatma yüzeyi
- Diz hareketlerini kademeli mekanizma ile ayarlayabilme
- 360° dönebilen çapraz kilitli tekerler (125 mm)
- Plastik koruyucu çarpma tamponları
- İdrar torbası askılığı
- Aksesuar Yuvaları
- Yüksekliği ayarlanabilir serum askısı
- Nano seramik kaplı elektrostatik toz boyalı metal aksam
- Sırt kayması
- Korkuluklarda aç göstergesi
- 85x190x12 cm 28DNS şilte
- Linear motors with min IPX4 protection for quiet operation
- Remote control
- Electrically adjustable back, foot and height movements
- Manual and electronic CPR
- Removable and mountable head and foot boards made of Polypropylene (PP)
- Manual adjustable Trendelenburg
- 4-piece lying surface made of ABS material
- Gradually adjustable knee movements
- 360° swivel cross lock castors (125 mm)
- Plastic protective bumpers against impact
- Urine bag holder
- Accessory Slots
- Height adjustable IV Pole
- Nano ceramic coated electrostatic powder painted metal parts
- Backrest Slippage
- Angle indicator on siderails
- 85x190x12 cm 28DNS mattress

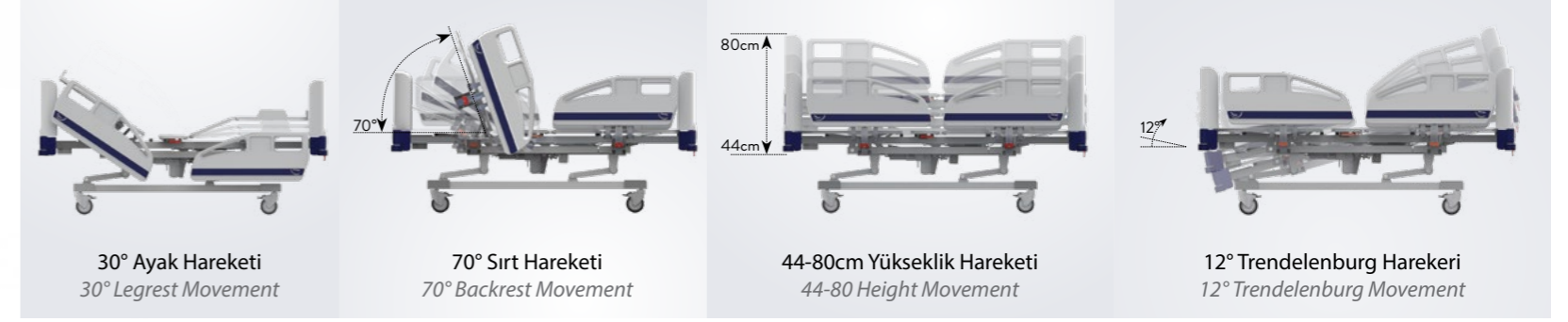

### Teknik Özellikler / Technical Features

En (Tampon)	Boy (Tampon)	Yükseklik Min.	Yükseklik Max.	Yatma Yüzeyi	Sırt Açısı	Ayak Açısı	Trendelenburg Açısı	Güvenli Taşıma Kapasitesi
Width (Over all)	Lenght (Over all)	Height Min.	Height Max.	Lying Surface	Backrest Angle	Legrest Angle	Trendelenburg Angle	Safety Working Capacity
103,5 cm	212,5 cm	44 cm	80 cm	85x190 cm	70°	30°	12°	230 kg

### Opsiyonel Özellikler / Optional Features

- Korkuluk Kumanda Paneli
- Hemşire Paneli
- Reklendirilebilir Başlık Ve Korkuluk Etiketleri
- X-Ray Kaset Taşıyıcı
- Kilitlenebilir Başlıklar
- Yatak Altı Aydınlatma
- Dosyalık
- Ayakcu Uzatma
- Hpl Yatma Yüzeyi
- Batarya
- Oksijen Tüplük
- Defibrilatör Sehpa
- Tartı
- Traksiyon Seti
- Siderails Control Panel
- Nurse control
- Sticker options in different colours for Head/Footboards and side rails
- X-Ray cassette holder
- Lockable Headboards and Footboards
- Underbed Light
- File Holder
- Leg extension part
- HPL lying surface
- Battery
- Oxygen holder
- Weighing system
- Defibrillator stand
- Traction set

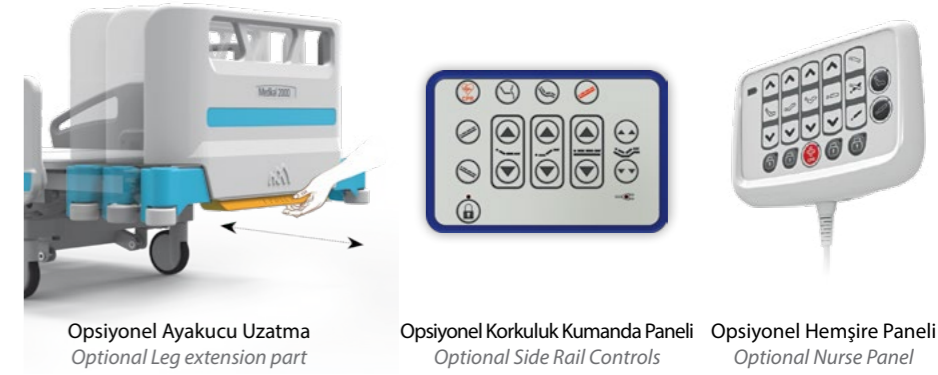

\*\*Kontrol ünitesi resimleri temsildir. / \*\*Control units pictures are representative.  
\*\*Tartı sistemi olan yataklarda yükseklik ölçüsü standart ölçüden farklılık göstermektedir. / \*\*The height measurement differs from the standard size in beds with a weighing system.





### Genel Özellikler / General Features

- Sessiz çalışma için min IPX4 korumaya sahip lineer motorlar
- El kumandası
- Elektronik olarak sırt, ayak ve yükseklik hareketi
- Manuel ve Elektronik CPR
- Polipropilen (PP) malzemeden imal edilmiş yan korkuluklar ve sökülüp takılabilen başucu ve ayakucu panelleri
- ABS malzemeden imal edilmiş 4 parçalı yatma yüzeyi
- Diz hareketlerini kademeli mekanizma ile ayarlayabilme
- 360° dönebilen çapraz kilitli tekerler (125 mm)
- Plastik koruyucu çarpma tamponları
- İdrar torbası askılığı
- Aksesuar Yuvaları
- Yüksekliği ayarlanabilir serum askısı
- Nano seramik kaplı elektrostatik toz boyalı metal aksam
- Sırt kayması
- Korkuluklarda açılı göstergesi
- 85x190x12 cm 28DNS şilte
- Linear motors with min IPX4 protection for quiet operation
- Remote control
- Electrically adjustable back, foot and height movements
- Manual and Electronic CPR
- Removable and mountable head and foot boards made of Polypropylene (PP)
- 4-piece lying surface made of ABS material
- Gradually adjustable knee movements
- 360° swivel cross lock castors (125 mm)
- Plastic protective bumpers against impact
- Urine bag holder
- Accessory Slots
- Height adjustable IV Pole
- Nano ceramic coated electrostatic powder painted metal parts
- Backrest Slippage
- Angle indicator on siderails
- 85x190x12 cm 28DNS mattress

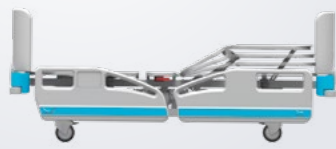

30° Ayak Hareketi  
30° Legrest Movement

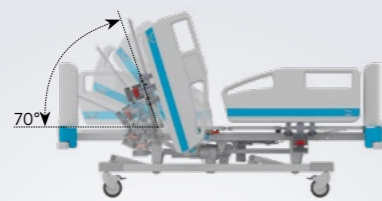

70° Sırt Hareketi  
70° Backrest Movement



43-78,5 cm Yükseklik Hareketi  
43-78,5 cm Height Movement

### Teknik Özellikler / Technical Features

En (Tampon)	Boy (Tampon)	Yükseklik Min.	Yükseklik Max.	Yatma Yüzeyi	Sırt Açısı	Ayak Açısı	Güvenli Taşıma Kapasitesi
Width (Over all)	Length (Over all)	Height Min.	Height Max.	Lying Surface	Backrest Angle	Legrest Angle	Safety Working Capacity
103,5 cm	212,5 cm	43 cm	78,5 cm	85x190 cm	70°	30°	230 kg

### Opsiyonel Özellikler / Optional Features

- Korkuluk kumanda paneli
- Hemşire paneli
- Reklendirilebilir başlık ve korkuluk etiketleri
- X-ray kaset taşıyıcı
- Kilitlenebilir başlıklar
- Yatak altı aydınlatma
- Dosyalık
- Ayakucu uzatma
- Hpl yatma yüzeyi
- Batarya
- Oksijen tüplük
- Defibrilatör sehpa
- Tartı
- Traksiyon seti
- Siderails Control Panel
- Nurse control
- Sticker options in different colours for Head/Footboards and side rails
- X-Ray cassette holder
- Lockable Headboards and Footboards
- Underbed Light
- File Holder
- Leg extension part
- HPL lying surface
- Battery
- Oxygen holder
- Weighing system
- Defibrillator stand
- Traction set

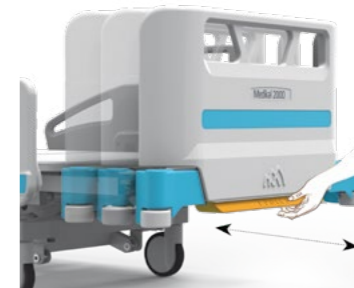

Opsiyonel Ayakucu Uzatma  
Optional Leg extension part



Opsiyonel Korkuluk Kumanda Paneli  
Optional Side Rail Controls



Opsiyonel Hemşire Paneli  
Optional Nurse Panel



30° Ayak Hareketi  
30° Legrest Movement

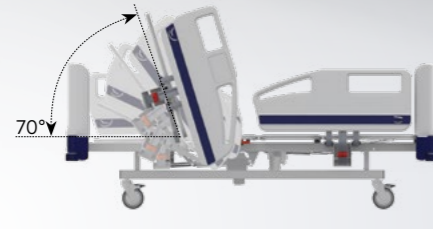

70° Sırt Hareketi  
70° Backrest Movement

### Genel Özellikler / General Features

- Sessiz çalışma için min IPX4 korumaya sahip lineer motorlar
- El kumandası
- Elektronik olarak sırt ve ayak hareketi
- Manuel CPR
- Polipropilen (PP) malzemeden imal edilmiş yan korkuluklar ve sökülüp takılabilen başucu ve ayakcu panelleri
- ABS malzemeden imal edilmiş 4 parçalı yatma yüzeyi
- Diz hareketlerini kademeli mekanizma ile ayarlayabilme
- 360° dönebilen çapraz kilitli tekerler (125 mm)
- Plastik koruyucu çarpma tamponları
- İdrar torbası askılığı
- Aksesuar Yuvaları
- Yüksekliği ayarlanabilir serum askısı
- Nano seramik kaplı elektrostatik toz boyalı metal aksam
- Sırt kayması
- Korkuluklarda açılı göstergesi
- 85x190x12 cm 28DNS şilte
- Linear motors with min IPX4 protection for quiet operation
- Remote control
- Electrically adjustable back and foot movements
- Manual CPR
- Removable and mountable head and foot boards made of Polypropylene (PP)
- 4-piece lying surface made of ABS material
- Gradually adjustable knee movements
- 360° swivel cross lock castors (125 mm)
- Plastic protective bumpers against impact
- Urine bag holder
- Accessory Slots
- Height adjustable IV Pole
- Nano ceramic coated electrostatic powder painted metal parts
- Backrest Slippage
- Angle indicator on siderails
- 85x190x12 cm 28DNS mattress

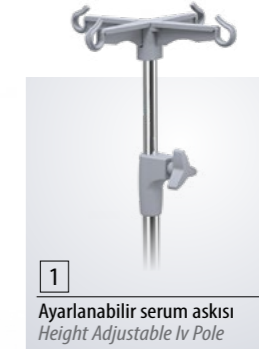
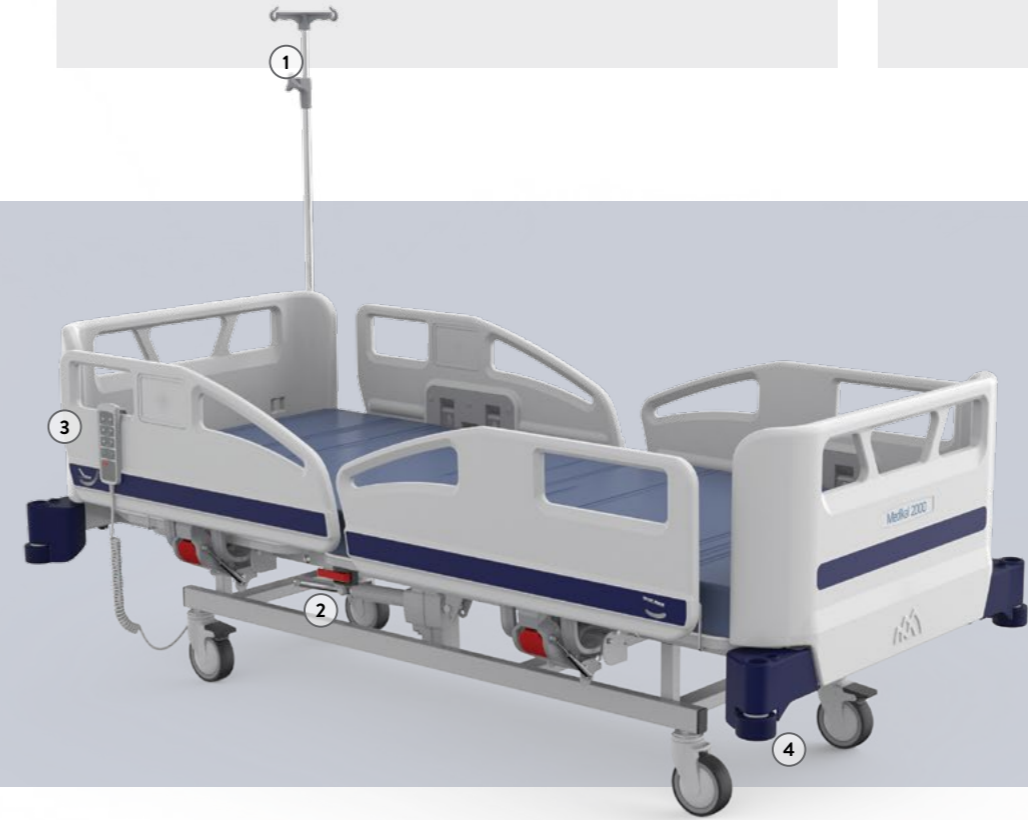

1 Ayarlanabilir serum askısı  
Height Adjustable Iv Pole



2 Standart El Kumandası  
Standard Remote Control



3 Manuel CPR Mandalı  
Manual CPR Arm



4 Çarpma Koruyucu Tamponlar  
Protective Bumpers Against Impact

### Teknik Özellikler / Technical Features

En (Tampon)	Boy (Tampon)	Yükseklik	Yatma Yüzeyi	Sırt Açısı	Ayak Açısı	Güvenli Taşıma Kapasitesi
Width (Over all)	Lenght (Over all)	Height	Lying Surface	Backrest Angle	Legrest Angle	Safety Working Capacity
103,5 cm	212,5 cm	42,5 cm	85x190 cm	70°	30°	230 kg

### Opsiyonel Özellikler / Optional Features

- Korkuluk Kumanda Paneli
- Reklendirilebilir Başlık ve Korkuluk Etiketleri
- X-Ray Kaset Taşıyıcı
- Kilitlenebilen Başlıklar
- Yatak Altı Aydınlatma
- Dosyalık
- Ayakcu Uzatma
- Hpl Yatma Yüzeyi
- Batarya
- Oksijen Tüplük
- Defibrilatör Sehpa
- Traksiyon Seti
- Siderails Control Panel
- Sticker options in different colours for Head/ Footboards and side rails
- X-Ray cassette holder
- Lockable Headboards and Footboards
- Underbed Light
- File Holder
- Leg extension part
- HPL lying surface
- Battery
- Oxygen holder
- Defibrillator stand
- Traction set



Opsiyonel Ayakcu Uzatma  
Optional Leg extension part



Opsiyonel Korkuluk Kumanda Paneli  
Optional Side Rail Controls



### Genel Özellikler / General Features

- Sessiz çalışma için min IPX4 korumaya sahip lineer motorlar
- Elektronik olarak koltuk pozisyonuna getirebilme özelliği
- El kumandası
- Elektronik olarak sırt ve ayak hareketi
- Polipropilen (PP) malzemeden imal edilmiş sökülüp takılabilen başucu ve ayakucu panelleri
- HPL malzemeden imal edilmiş 5 parçalı yatma yüzeyi
- Diz hareketlerini kademeli mekanizma ile ayarlayabilme
- 360° dönebilen merkezi kilitli
- tekerler (150 mm)
- Plastik koruyucu çarpma tamponları
- İdrar torbası askılığı
- Aksesuar Yuvaları
- Yükseklığı ayarlanabilir serum askısı
- Nano seramik kaplı elektrostatik toz boyalı metal aksam
- Sırt kayması
- 85x190x12 cm 28DNS şilte
- Yatak altı aydınlatma
- Linear motors with min IPX4 protection for quiet operation
- Seat position features operated electrically
- Remote control
- Backrest and Legrest movements electrically adjustable
- Removable and mountable head and foot boards made of polypropylene (PP) material
- 5-piece lying surface made of HPL material
- Adjusting the knee movements with the gradual mechanism
- 360° swivel castors with central lock (150 mm)
- Plastic protective impact bumpers
- Urine bag holder
- Accessory Slots
- Height adjustable IV Pole
- Nano ceramic coated electrostatic powder painted metal parts
- Backrest Slippage
- 85x190x12 cm 28DNS mattress
- Underbed Light

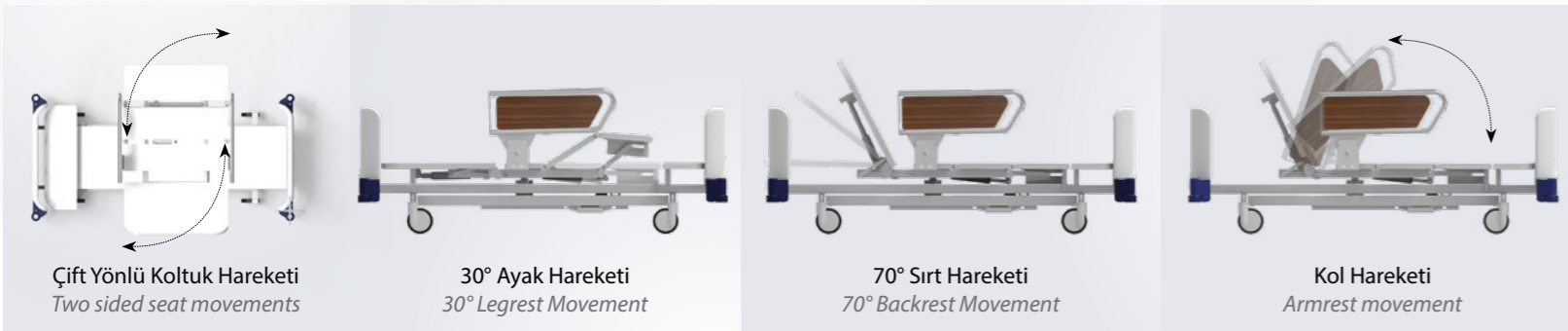

### Teknik Özellikler / Technical Features

En (Tampon) Width (Over all)	Boy (Tampon) Lenght (Over all)	Yükseklik Height	Yatma Yüzeyi Lying Surface	Sırt Açısı Backrest Angle	Ayak Açısı Legrest Angle	Güvenli Taşıma Kapasitesi Safety Working Capacity
103,5 cm	214 cm	42 cm	85x190 cm	70°	30°	230 kg

### Opsiyonel Özellikler / Optional Features

- Reklendirilebilir başlık etiketleri
- Kilitlenebilir başlıklar
- Dosyalık
- Sticker options in different colours for head/leg boards and side rails
- Lockable Headboards and Footboards
- File Holder







4  
MOTOR  
MOTORS

### Genel Özellikler / General Features

- Sessiz çalışma için min IPX4 korumaya sahip lineer motorlar
- El kumandası
- Fonksiyon kilitleme özelliğine sahip hemşire paneli
- Elektronik olarak sırt, ayak, yükseklik, trendelenburg ve ters trendelenburg hareketi
- Manuel ve Elektronik CPR
- Polipropilen (PP) malzemeden imal edilmiş yan korkuluklar ve sökülüp takılabilen başucu ve ayakucu panelleri
- Kompak malzemeden imal 4 parçalı yatma yüzeyi
- Diz hareketlerini kademeli mekanizma ile ayarlayabilme
- 360° dönebilen merkezi kilitli tekerler (150 mm)
- Plastik koruyucu çarpma tamponları
- İdrar torbası askılığı
- Aksesuar Yuvaları
- Yüksekliği ayarlanabilir serum askısı
- Nano seramik kaplı elektrostatik toz boyalı metal aksam
- Korkuluklarda aç göstergesi
- 78x160x12 cm 28DNS şilte
- Batarya
- Linear motors with min IPX4 protection
- Remote control
- Nurse panel with function locking feature.
- Electronic adjustment of backrest, legrest height, trendelenburg and reverse trendelenburg positions
- Manual and Electronic CPR
- Foldable side rails and removable head/foot boards made of PP
- 4 sections lying surface made of HPL
- Manual gradual adjustment of foot section.
- 360° turning casters (150 mm) with central and directional lock
- Bumpers on 4 corners
- Urine bag holder
- Holes for IV Pole and Lifting Pole on 4 corners
- IV Pole with height adjustment
- Nano ceramic coated electrostatic powder painted metal parts
- Angle indicators on side rails
- 78x160x12 cm 28DNS Mattress
- Battery

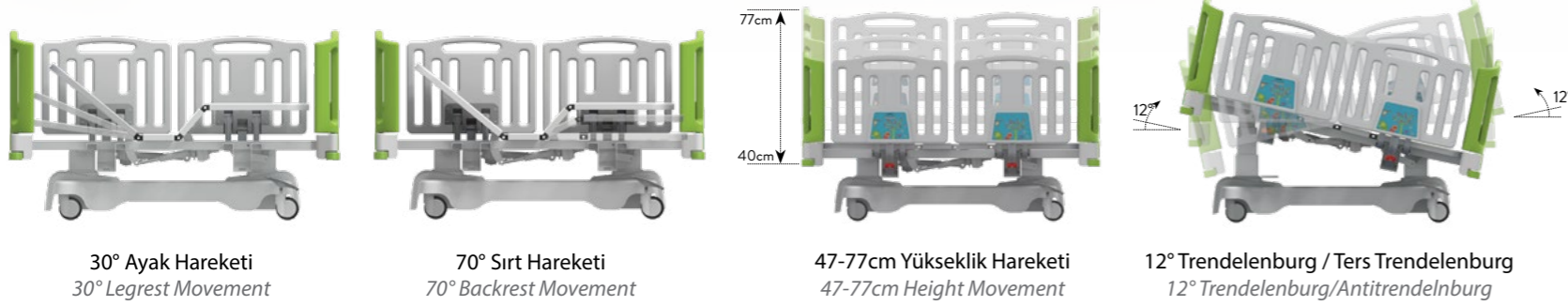

### Teknik Özellikler / Technical Features

En (Tampon)	Boy (Tampon)	Yükseklik Min.	Yükseklik Max.	Yatma Yüzeyi	Sırt Açısı	Ayak Açısı	Trendelenburg Açısı	Ters Trendelenburg Açısı	Güvenli Taşıma Kapasitesi
Width (Over all)	Lenght (Over all)	Height Min.	Height Max.	Lying Surface	Backrest Angle	Legrest Angle	Trendelenburg Angle	Antitrendelenburg Angle	Safety Working Capacity
103,5 cm	180 cm	47 cm	77 cm	78x162cm	70°	30°	12°	12°	230 kg

### Opsiyonel Özellikler / Optional Features

- Reklendirilebilir başlık ve korkuluk etiketleri
- Kilitlenebilir başlıklar
- Yatak altı aydınlatma
- Dosyalık
- Ayakucu uzatma
- Tartı
- Oksijen tüplük
- Defibrilatör sehпасı
- Traksiyon seti
- Sticker options in different colours for head/leg boards and side rails
- Lockable Head/Footboards
- Underbed Light
- Chart Holder
- Foot extension
- Weighing system
- Oxygen holder
- Defibrillator stand
- Traction set



## Genel Özellikler / General Features

- Sessiz çalışma için min IPX4 korumaya sahip lineer motorlar
- El kumandası
- Elektronik olarak sırt, ayak ve yükseklik hareketi
- Manuel ve Elektronik CPR
- Polipropilen (PP) malzemeden imal edilmiş yan korkuluklar ve sökülüp takılabilen başucu ve ayakucu panelleri
- Kompak malzemeden imal 4 parçalı yatma yüzeyi
- Diz hareketlerini kademeli mekanizma ile ayarlayabilme
- 360° dönebilen çapraz kilitli tekerler (125 mm)
- Plastik koruyucu çarpma tamponları
- İdrar torbası askılığı
- Aksesuar Yuvaları
- Yüksekliği ayarlanabilir serum askısı
- Nano seramik kaplı elektrostatik toz boyalı metal aksam
- Korkuluklarda aç göstergesi
- 78x160x12 cm 28DNS şilte
- Linear motors with min IPX4 protection
- Remote control
- Electronic adjustment of backrest, legrest and height positions
- Manuel and Electronic CPR
- Foldable side rails and removable head/foot boards made of PP
- 4 sections lying surface made of HPL
- Manual gradual adjustment of foot section.
- 360° turning castors (125 mm), 2 of them with brakes.
- Bumpers on 4 corners
- Urine bag holder
- Holes for IV Pole and Lifting Pole on 4 corners
- Height adjustable IV Pole
- Nano ceramic coated electrostatic powder painted metal parts
- Angle indicators on side rails
- 78x160x12 cm 28DNS mattress

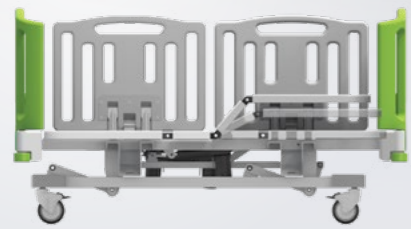

30° Ayak Hareketi  
30° Legrest Movement

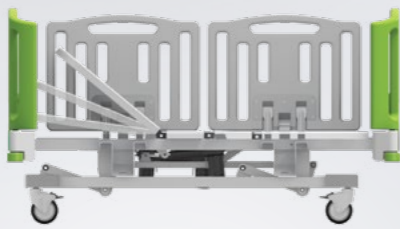

70° Sırt Hareketi  
70° Backrest Movement



44-77cm Yükseklik Hareketi  
44-77cm Height Movement

## Teknik Özellikler / Technical Features

En (Tampon)	Boy (Tampon)	Yükseklik Min.	Yükseklik Max.	Yatma Yüzeyi	Sırt Açısı	Ayak Açısı	Güvenli Taşıma Kapasitesi
Width (Over all)	Lenght (Over all)	Height Min.	Height Max.	Lying Surface	Backrest Angle	Legrest Angle	Safety Working Capacity
103,5 cm	180 cm	44 cm	77 cm	78x162 cm	70°	30°	230 kg

## Opsiyonel Özellikler / Optional Features

- Hemşire Paneli
- Reklendirilebilir başlık ve korkuluk etiketleri
- Kilitlenebilen başlıklar
- Yatak altı aydınlatma
- Dosyalık
- Ayakucu uzatma
- Batarya
- Oksijen tüplük
- Defibrilatör sehпасı
- Traksiyon seti
- Nurse control panel
- Sticker options in different colours for head/leg boards and side rails
- Lockable Head/
- Footboards
- Underbed Light
- File Holder
- Foot extension
- Battery
- Oxygen holder
- Defibrillator stand
- Traction set





1 Ayarlanabilir serum askısı  
Height Adjustable Iv Pole



2 Çarpma Koruyucu Tamponlar  
Impact Protection Bumpers



3 Kolay Açılır Kapanır Yan Korkuluk  
Easy foldable Side Rails



MN-02



MN-01



MN-03

Opsiyonel Özellikler / Optional Features

- Reklendirilebilir başlık etiketleri
- Kompakt yatma yüzeyi
- Dosyalık
- Oksijen tüplük
- Defibrilatör sehpa
- Traksiyon seti
- Sticker options in different colours for head/footboards boards and side rails
- HPL lying surface
- File Holder
- Oxygen holder
- Defibrillator stand
- Traction set

Genel Özellikler / General Features

- Krank sistemli sırt hareketi (MN-01 için)
- Krank sistemli sırt ve ayak hareketi (MN-02 için)
- Krank sistemli sırt, ayak ve yükseklik hareketi (MN-03 için)
- Kolay açılıp kapanabilen yan korkuluklar
- Polipropilen (PP) malzemeden imal edilmiş sökülüp takılabilen başucu ve ayakucu panelleri
- Dört parçalı delikli sac yatma yüzeyi (MN-02 ve MN-03 için)
- İki parçalı delikli sac yatma yüzeyi (MN-01 için)
- Diz hareketlerini kademeli mekanizma ile ayarlayabilme
- 360° dönebilen çapraz kilitli tekerler (125 mm)
- Plastik koruyucu çarpma tamponları
- İdrar torbası askılığı
- Yüksekliği ayarlanabilir serum askısı
- Nano seramik kaplı elektrostatik toz boyalı metal aksam
- 28 dansite şilte
- Backrest adjustment by crank (MN-01)
- Legrest and backrest adjustment by crank (MN-02)
- Height, legrest and backrest adjustment by crank (MN-03)
- Detachable head and footboards made of (PP) polypropylene
- Four-piece sheet metal lying surface (MN-02 and MN-03)
- Two-piece sheet metal lying surface (MN-01)
- Gradually adjustable knee movements
- 360° Swivel cross lock castors (125 mm)
- Plastic bumpers against impact
- Urine bag holder
- Height adjustable IV Pole
- Nano ceramic coated electrostatic powder painted metal parts
- 28 Dns mattress
- Easy to open and close side rails.

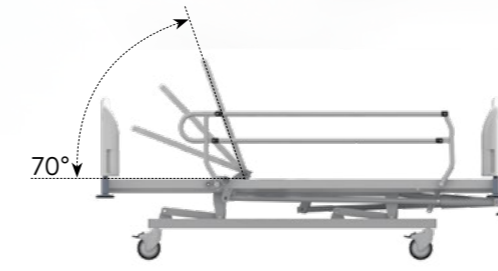

70° Sırt Hareketi  
70° Backrest Movement  
MN-01 / MN-02 / MN-03

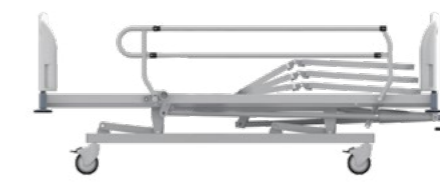

30° Ayak Hareketi  
30° Legrest Movement  
MN-02 / MN-03

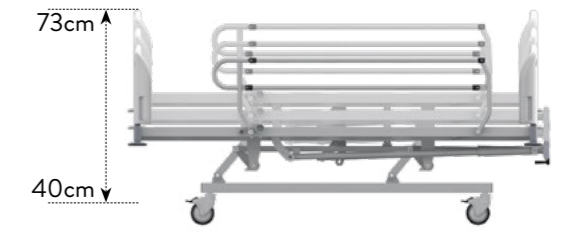

40-73cm Yükseklik Hareketi  
40-73cm Height Movement  
MN-03

Teknik Özellikler / Technical Features

Model	En (Tampon)	Boy (Tampon)	Yükseklik Min.	Yükseklik Max.	Yatma Yüzeyi	Sırt Açısı	Ayak Açısı	Güvenli Taşıma Kapasitesi
Models	Width (Over all)	Lenght (Over all)	Height Min.	Height Max.	Lying Surface	Backrest Angle	Legrest Angle	Safety Working Capacity
MN-01	109 cm	216 cm	40 cm		90x190 cm	70°	-	230 kg
MN-02	109 cm	216 cm	40 cm		90x190cm	70°	30°	230 kg
MN-03	109 cm	216 cm	40 cm	73 cm	90x190 cm	70°	30°	230 kg



### Genel Özellikler / General Features

- Nano seramik kaplı elektrostatik toz boyalı metal aksam.
- Minimum IPX4 korumalı motorlar ve kontrol kutusu.
- El kumandasındaki tuşlar sayesinde elektronik olarak başucu, yükseklik, trendelenburg, ters trendelenburg, ayak destek ve baldır destek pozisyonları.
- Kolay sökülüp takılabilen krom nikel malzemeden imal atık tası.
- Korozyona karşı dirençli, krom nikel kaplamalı aksesuarlar.
- Ayarlanabilen baldır destek.
- Kolay temizlenebilen hijyenik tasarıma sahip, tamamen ABS plastik kaplı şase.
- Masanın yere sabitlenebilme özelliği.
- Kağıt havluluk.
- Kesintisiz çalışma için batarya.
- Yumuşaklık hissi veren, kolay temizlenebilir poliüretan malzemeden imal yatma yüzeyi.
- Nano ceramic coated electrostatic powder painted metal parts.
- Minimum ipx4 motors and control box.
- Electronically controlled backrest, height, trendelenburg, antitrendelenburg, leg support and calf support positions by remote control.
- Detachable chromium-nickel waste bowl.
- Anticorrosive chromium-nickel covered accessories.
- Adjustable calf support.
- Easy to clean designed abs plastic chassis.
- Ability to fixing on the floor
- Towel roller.
- Battery for non-stop operation.
- Soft, easy to clean polyurethane lying surface.



20° Trendelenburg / 3° Ters Trendelenburg  
20° Trendelenburg / 3° Antitrendelenburg

69-94 cm Yükseklik Hareketi  
69-94 cm Height Movement

52° Sirt Hareketi  
52° Backrest Movement

Ayarlanabilir baldır destek  
Adjustable Calf support

### Teknik Özellikler / Technical Features

En (Tampon)	Boy (Tampon)	Yükseklik Min.	Yükseklik Max.	Sirt Yatma Yüzeyi	Oturak Yatma Yüzeyi	Sirt Açısı	Trend. Açısı	Ters Trend. Açısı	Güvenli Taşıma Kapasitesi
Width (Over all)	Lenght (Over all)	Height Min.	Height Max.	Lying Surface	Sitting Surface	Backrest Angle	Trend. Angle	Antitrend. Angle	Safety Working Capacity
70 cm	131 cm	69 cm	94 cm	61x91 cm	58x36 cm	52°	20°	3°	230 kg

### Opsiyonel Özellikler / Optional Features

- Hareketli ayak destek
- Kol destek
- Serum askısı
- Uzatma minderi
- Hareketli tabure
- Sırtlığa sahip hareketli tabure
- Ayaklığa sahip hareketli tabure
- Sırtlık ve ayaklığa sahip hareketli tabure
- Spiral aydınlatma
- Ayak kumandası
- Movable Leg Support
- Arm Support
- IV Pole
- Extension Mattress
- Movable Stool
- Movable Stool With Backrest
- Movable Stool With Footrest
- Movable Stool With Backrest And Footrest
- Foot control
- Spiral lighting



Standart El Kumandası  
Standard Remote Control



Baldır Destek Aparatı  
Calf support

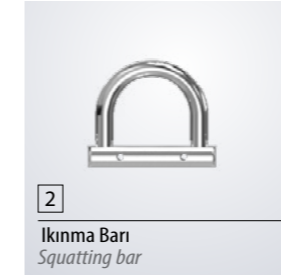

İkinma Barı  
Squatting bar



Sökülebilir ayakucu uzatma  
Detachable leg extension



15° Trendelenburg / 15° Ters Trendelenburg  
15° Trendelenburg / 15° Antitrendelenburg



63-105 cm Yükseklik Hareketi  
63-105 cm Height Movement



60° Sırt Hareketi  
60° Backrest Movement

### Genel Özellikler / General Features

- Sessiz çalışma için min IPX4 korumaya sahip lineer motorlar
- El kumandası
- Elektronik olarak sırt,yükseklik,trendelenburg ve ters trendelenburg hareketi
- Nano seramik kaplı elektrostatik toz boyalı metal aksam
- Aksesuar bağlantıları için aksesuar rayı
- Poliüretan dolgulu 2 parçalı döşeme
- Sökülebilir ayakucu uzatma
- Kesintisiz çalışma için batarya
- Yere sabitlenebilme özelliği
- ABS plastik kaplı alt şase
- Atık taşı
- İkinma barı
- Baldır destek
- Minimum IPX4 protection liner motors for silent operation
- Remote control
- Electrically controlled backrest, height, trendelenburg and antitrendelenburg movements
- Nano ceramic coated electrostatic powder painted metal parts
- Accessory rail for accessory connections
- 2-piece upholstery with polyurethane filling
- Detachable leg extension
- Battery for non-stop operating
- Ability to be fixed to the ground
- ABS plastic covered bottom chassis
- Waste bowl
- Squatting Bar
- Calf support

### Teknik Özellikler / Technical Features

En (Tampon)	Boy (Tampon)	Yükseklik Min.	Yükseklik Max.	Sırt Yatma Yüzeyi	Oturak Yatma Yüzeyi	Sırt Açısı	Trend. Açısı	Ters Trend. Açısı	Güvenli Taşıma Kapasitesi
Width (Over all)	Lenght (Over all)	Height Min.	Height Max.	Lying Surface	Sitting Surface	Backrest Angle	Trend. Angle	Antitrend. Angle	Safety Working Capacity
66 cm	167 cm	63 cm	105 cm	65x81 cm	52.5x65 cm	60°	15°	15°	230 kg

### Opsiyonel Özellikler / Optional Features

- Ayak kumandası
- Alternatif renk seçenekleri
- Ayarlanabilir serum askısı
- Spiral aydınlatma
- Foot control
- Alternative colour options
- Height adjustable IV pole
- Spiral lighting



Opsiyonel Ayak Kumandası  
Optional foot control



### Genel Özellikler / General Features

- Sessiz çalışma için min IPX4 korumaya sahip lineer motorlar
- Fonksiyon kilitleme özelliğine sahip hemşire paneli
- Kompak malzemeden imal 3 parçalı yatma yüzeyi
- Sırt kısmında x ray özelliği
- 360° dönebilen merkezi fren sistemli tekerler (150 mm)
- Polipropilen (PP) malzemeden imal edilmiş yan korkuluklar ve sökülüp takılabilen başucu ve ayakucu panelleri
- Elektronik ve manuel CPR özelliği
- Plastik koruyucu çarpma tamponları
- Gizlenebilir ayakucu uzatma
- İdrar torbası askılığı
- Aksesuar bağlantıları için aksesuar rayı ve aksesuar yuvaları
- Atık taşı
- İkinma barı
- Baldır destek
- Batarya
- Yüksekliği ayarlanabilir serum askısı
- Nano seramik kaplı elektrostatik toz boyalı metal aksam
- Sirt kayması
- Korkuluklarda aç göstergesi
- 2 parçalı ABS plastik kaplı alt şase
- 28 dansite 2 parçalı şilte

- Linear motors with min IPX4 protection for quiet operation
- Nurse panel with function locking feature
- 3-piece lying surface made of compact material
- X ray feature on the back
- 360° swivel casters with central brake system (150 mm)
- Polypropylene (PP) side rails and removable head and foot panels
- Electronic and manual CPR feature
- Plastic protective crash bumpers
- Concealable foot extension
- Urine bag holder
- Accessory rail and accessory slots for accessory connections
- Waste bowl
- Squatting bar
- Calf support
- Battery
- Height adjustable IV Pole
- Nano ceramic coated electrostatic powder painted metal parts
- Backrest slippage
- Angle indicator on handrails
- 2-piece ABS plastic covered bottom chassis
- 28 density 2 piece mattress



### Teknik Özellikler / Technical Features

En (Tampon)	Boy (Tampon)	Yükseklik Min.	Yükseklik Max.	Yatma Yüzeyi Kapalı	Yatma Yüzeyi Açık	Sırt Açısı	Ayak Açısı	Trend. Açısı	Ters Trend. Açısı	Güvenli Taşıma Kapasitesi
Width (Over all)	Length (Over all)	Height Min.	Height Max.	Lying Surface Closed	Lying Surface Open	Backrest Angle	Legrest Angle	Trend. Angle	Antitrend. Angle	Safety Working Capacity
103,5 cm	209,5 cm	62,5 cm	103 cm	85x144 cm	85x190 cm	70°	30°	12°	12°	230 kg

### Opsiyonel Özellikler / Optional Features

- Reklendirilebilir başlık ve korkuluk etiketleri
- X-Ray Kaset taşıyıcı
- Kilitlenebilir başlıklar
- Topuk desteği
- Egzersiz barı
- El kumandası
- Yatak altı aydınlatma
- Dosyalık
- Ayak kumandası
- X-Ray Cassette carrier
- Lockable Headboard
- Heel support
- Birthing Bar
- Hand controller
- Underbed Light
- File holder
- Foot control



Opsiyonel Ayak Kumandası  
Optional foot control



Opsiyonel Korkuluk Kumanda Paneli  
Optional Side Rail Controls



### Genel Özellikler / General Features

- Sessiz çalışma için min IPX4 korumaya sahip lineer motorlar
- El kumandası
- Elektronik olarak sırt, ayak, yükseklik ve trendelenburg hareketi
- Manuel CPR
- Polipropilen (PP) malzemeden imal edilmiş yan korkuluklar ve sökülüp takılabilen başucu ve ayakucu panelleri
- Kompak malzemeden imal sırt yatma yüzeyi
- ABS malzemeden imal oturak ve ayakucu uzatma kısmı
- 360° dönebilen merkezi kilitli tekerler (150 mm)
- Plastik koruyucu çarpma tamponları
- Aksesuar bağlantıları için aksesuar rayı ve aksesuar yuvaları
- İdrar torbası askılığı
- Yüksekliği ayarlanabilir serum askısı
- Nano seramik kaplı elektrostatik toz boyalı metal aksam
- Korkuluklarda açılı göstergesi
- Atık taşı
- İkinma barı
- Batarya
- 2 parçalı ABS plastik kaplı alt şase
- 28 dansite 2 parçalı şilte
- Linear motors with min IPX4 protection for quiet operation
- Remote control
- Electronically back, foot, height and trendelenburg movement
- Manual CPR
- Polypropylene (PP) side rails and removable head and foot panels
- Back lying surface made of compact material
- Made of ABS material, seat and foot extension part
- 360° swivel casters with central lock (150 mm)
- Plastic protective crash bumpers
- Accessory rail and accessory slots for accessory connections
- Urine bag holder
- Height adjustable IV pole
- Nano ceramic coated electrostatic powder painted metal parts
- Angle indicator on siderails
- Waste bowl
- Straining bar
- Battery
- 2-piece ABS plastic covered bottom chassis
- 28 density 2 piece mattress



Sırt Hareketi 70°  
Backrest Movement 70°



60-85cm Yükseklik Hareketi  
60-85cm Height Movement



15° Trendelenburg  
15° Trendelenburg

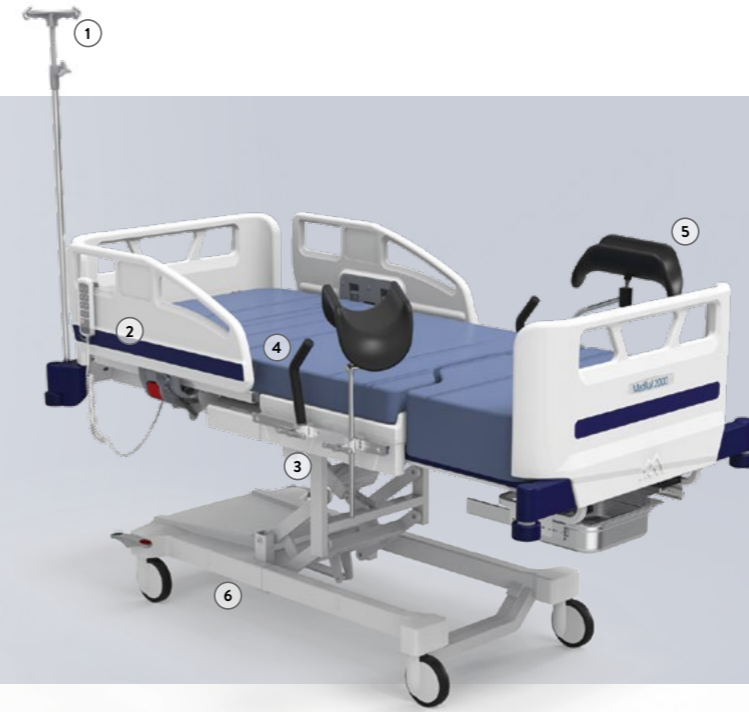

### Teknik Özellikler / Technical Features

En (Tampon)	Boy (Tampon)	Yükseklik Min.	Yükseklik Max.	Yatma Yüzeyi Kapalı	Yatma Yüzeyi Açık	Sırt Açısı	Trendelenburg Açısı	Güvenli Taşıma Kapasitesi
Width (Over all)	Lenght (Over all)	Height Min.	Height Max.	Lying Surface Closed	Lying Surface Open	Backrest Angle	Trendelenburg Angle	Safety Working Capacity
103,5 cm	210 cm	60 cm	85 cm	85x144 cm	85x190 cm	70°	15°	230 kg

### Opsiyonel Özellikler / Optional Features

- Reklendirilebilir başlık ve korkuluk etiketleri
- Kilitlenebilir başlıklar
- Topuk desteği
- Ayak kumandası
- Egzersiz barı
- Yatak altı aydınlatma
- Dosyalık
- Colorable header and railing tags
- Lockable headboards
- Heel support
- Birthing Bar
- Underbed Light
- File holder
- Foot control



Opsiyonel Ayak Kumandası  
Optional foot control



## Genel Özellikler / General Features

- Nano seramik kaplı elektrostatik toz boyalı metal aksam
- Kompak malzemeden imal 4 parçalı yatma yüzeyi
- Kolay açılıp kapanabilen yan korkuluklar
- Dört köşesinde çarpma tamponları
- Teleskopik ayarlanabilen katlanır serum askısı
- Plastik kaplı katlanabilir itme barları
- 360° dönebilen merkezi fren sistemli tekerler (200 mm)
- 5.Teker (Sedyede istenilen yönde hareket kolaylığı sağlar)
- Ayak pedalları ile hidrolik kontrollü yükseklik, trendelenburg ve ters trendelenburg ayarı
- Gazlı amortisör kontrollü sırt ve ayakucu ayarı
- Diz hareketlerini kademeli mekanizma ile ayarlayabilme
- Alüminyum teleskopik kolonlar
- ABS plastik kaplı alt şase
- Oksijen tüpü taşıma yeri
- Hasta bağlama kemeri
- 28 dansite şilte (66x193x8cm)
- X-ray kaset taşıyıcısı

- Nano ceramic coated electrostatic powder coated metal parts
- 4-part lying surface made of compact material
- Easy to open and close side rails
- Crash bumpers on all four corners
- Telescopic adjustable IV pole
- Plastic coated foldable push bars
- 360° swivel central locking wheels (200 mm)
- 5.Th Castor (Provides ease of movement in the desired direction on the stretcher)
- Hydraulically controlled height, trendelenburg and reverse trendelenburg adjustment with foot pedals
- Gas spring controlled back and foot adjustment
- Ability to adjust knee movements with gradual mechanism
- Aluminum telescopic columns
- ABS plastic coated sub-chassis
- Oxygen cylinder holder
- Patient restraint belt
- 28 density mattress (66x193x8cm)
- X-Ray Cassette carrier

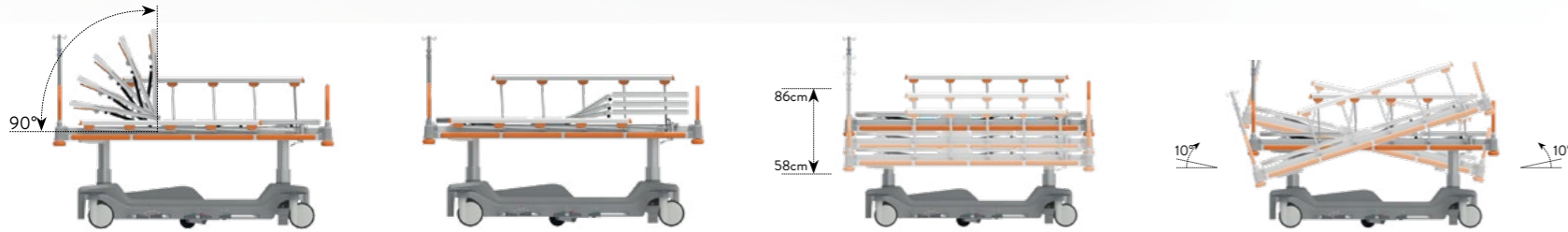
90° Sırt Hareketi  
90° Backrest Movement30° Ayak Hareketi  
30° Legrest Movement58-86 cm Yükseklik Hareketi  
58-86 cm Height Movement10° Trendelenburg / Ters Trendelenburg  
10° Trendelenburg/Antitrendelenburg

## Teknik Özellikler / Technical Features

En	Boy	Yükseklik Min.	Yükseklik Max.	Yatma Yüzeyi	Ayak Açısı	Sırt Açısı	Trendelenburg Açısı	Ters Trendelenburg Açısı	Güvenli Taşıma Kapasitesi
Width	Length	Height Min.	Height Max.	Lying Surface	Legrest Angle	Backrest Angle	Trendelenburg Angle	Antitrendelenburg Angle	Safety Working Capacity
84 cm	208,5 cm	58 cm	86 cm	60 x 193 cm	30°	90°	10°	10°	230 kg

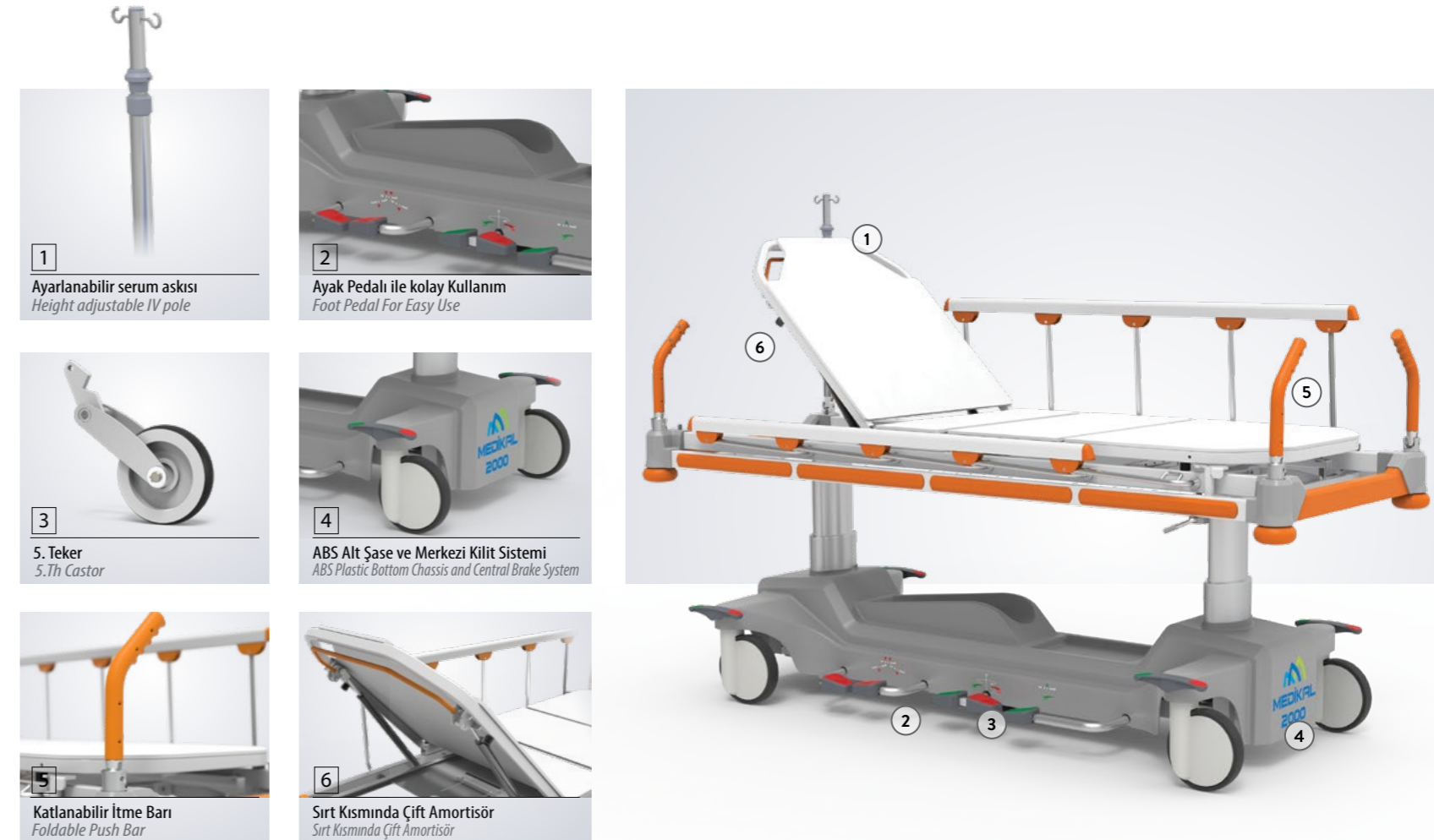
1  
Ayarlanabilir serum askısı  
Height adjustable IV pole2  
Ayak Pedalı ile kolay Kullanım  
Foot Pedal For Easy Use3  
5. Teker  
5.Th Castor4  
ABS Alt Şase ve Merkezi Kilit Sistemi  
ABS Plastic Bottom Chassis and Central Brake System5  
Katlanabilir İtme Bar  
Foldable Push Bar6  
Sırt kısmında Çift Amortisör  
Sırt kısmında Çift Amortisör





## Genel Özellikler / General Features

- Nano seramik kaplı elektrostatik toz boyalı metal aksam
- Kompak malzemeden imal 2 parçalı yatma yüzeyi
- Kolay açılıp kapanabilen metal yan korkuluklar
- Dört köşesinde serum askılığı yuvası ve çarpma tamponları
- Teleskopik ayarlanabilen serum askısı
- Paslanmaz çelikten imal itme barları
- 360° dönebilen merkezi fren sistemli tekerler (200 mm)
- 5.Teker (Sedyede istenilen yönde hareket kolaylığı sağlar)
- Ayak pedalları ile hidrolik kontrollü yükseklik, trendelenburg ve ters trendelenburg ayarı
- Gazlı amortisör kontrollü sırt ayarı
- Alüminyum teleskopik kolonlar
- ABS plastik kaplı alt şase
- Oksijen tüpü taşıma yeri
- Hasta bağlama kemeri
- 60x190x8cm 28 DNS şilte
- X-ray kaset taşıyıcısı
- Nano ceramic, coated electrostatic powder painted metal parts
- 2 sections lying surface made of HPL
- Easy foldable side rails made of metal
- Bumpers and IV Pole slots on 4 corners
- Height adjustable IV Pole
- Pushing bars made of stainless steel
- 360° turning casters (200 mm) with central and directional lock
- 5.Th Castor (Provides ease of movement in the desired direction on the stretcher)
- Hydraulic adjustment by pedal control of height, trendelenburg and reverse trendelenburg positions.
- Backrest adjustment by gas spring
- Telescopic aluminum columns
- ABS plastic covered lower chassis
- Oxygen tube holder
- Body fixing belt
- 60x190x8cm 28 DNS Mattress
- X-ray cassette holder

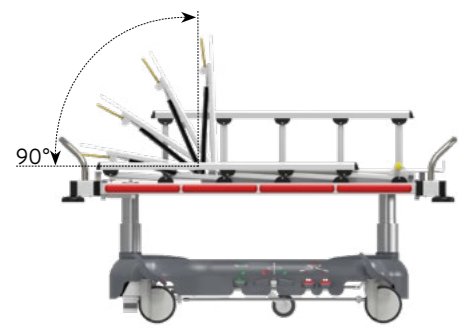

90° Sırt Hareketi  
90° Backrest Movement



62-90 cm Yükseklik Hareketi  
62-90 cm Height Movement

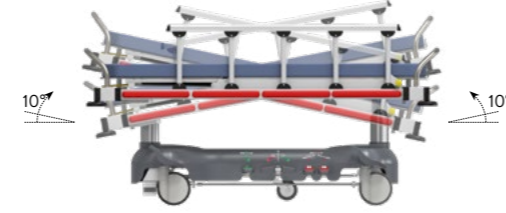

10° Trendelenburg / Ters Trendelenburg  
10° Trendelenburg/Antitrendelenburg

## Teknik Özellikler / Technical Features

En	Boy	Yükseklik Min.	Yükseklik Max.	Yatma Yüzeyi	Sırt Açısı	Trendelenburg Açısı	Ters Trendelenburg Açısı	Güvenli Taşıma Kapasitesi
Width	Lenght	Height Min.	Height Max.	Lying Surface	Backrest Angle	Trendelenburg Angle	Antitrendelenburg Angle	Safety Working Capacity
84 cm	208,5 cm	62 cm	90 cm	60 x 193,5 cm	90°	10°	10°	230 kg



1 Ayarlanabilir serum askısı  
Height adjustable IV pole



2 Ayak Pedalı ile kolay Kullanım  
Foot Pedal For Easy Use



3 5. Teker  
5.Th Castor



4 ABS Alt Şase ve Merkezi Kilit Sistemi  
ABS Plastic Bottom Chassis and Central Brake System

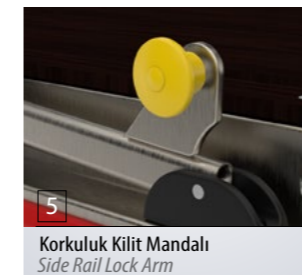

5 Korkuluk Kilit Mandalı  
Side Rail Lock Arm



6 Sırt kısmında Çift Amortisör  
Sırt kısmında Çift Amortisör





## Genel Özellikler / General Features

- Nano seramik kaplı elektrostatik toz boyalı metal aksam
- Kompak malzemeden imal 2 parçalı yatma yüzeyi
- Kolay açılıp kapanabilen metal yan korkuluklar
- Dört köşesinde serum askılığı yuvası ve çarpma tamponları
- Teleskopik ayarlanabilen serum askısı
- Paslanmaz çelikten imal itme barları
- 360° dönebilen merkezi fren sistemli tekerler (150 mm)
- Hidrolik kontrollü yükseklik ayarı
- Gazlı amortisör kontrollü sırt ayarı
- Gazlı amortisör kontrollü trendelenburg ayarı
- ABS plastik kaplı alt şase
- Hasta bağlama kemeri
- 60x190x8cm 28 DNS şilte
- X-ray kaset taşıyıcısı
- Opsiyonel tüplük özelliği
- Nano ceramic coated electrostatic powder painted metal parts
- 2 sections lying surface made of HPL
- Easy foldable side rails made of metal
- Bumpers and IV pole hols on 4 corners
- Height adjustable IV Pole
- Pushing bars made of stainless steel
- 360° turning casters (150 mm) with central lock
- Hydraulic height adjustment by pedal control
- Trendelenburg adjustment by gas spring
- Backrest adjustment by gas spring
- ABS plastic covered lower chassis
- Patient belt
- 60x190x8cm 28 DNS Mattress
- X-ray cassette holder
- Optional tube holder feature

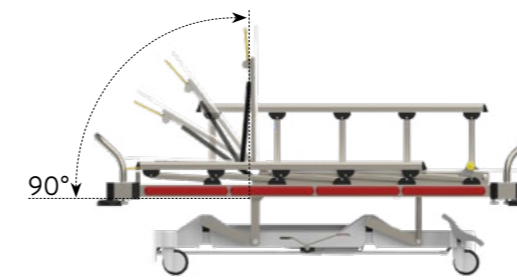
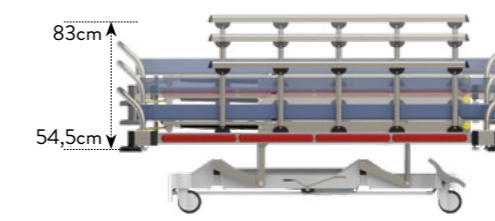
90° Sırt Hareketi  
90° Backrest Movement54,5-83 cm Yükseklik Hareketi  
54,5-83 cm Height Movement12° Trendelenburg  
12° Trendelenburg

## Teknik Özellikler / Technical Features

En	Boy	Yükseklik Min.	Yükseklik Max.	Yatma Yüzeyi	Sırt Açısı	Trendelenburg Açısı	Güvenli Taşıma Kapasitesi
Width	Lenght	Height Min.	Height Max.	Lying Surface	Backrest Angle	Trendelenburg Angle	Safety Working Capacity
84 cm	208,5 cm	54,5 cm	83 cm	60 x 193,5 cm	90°	12°	230 kg

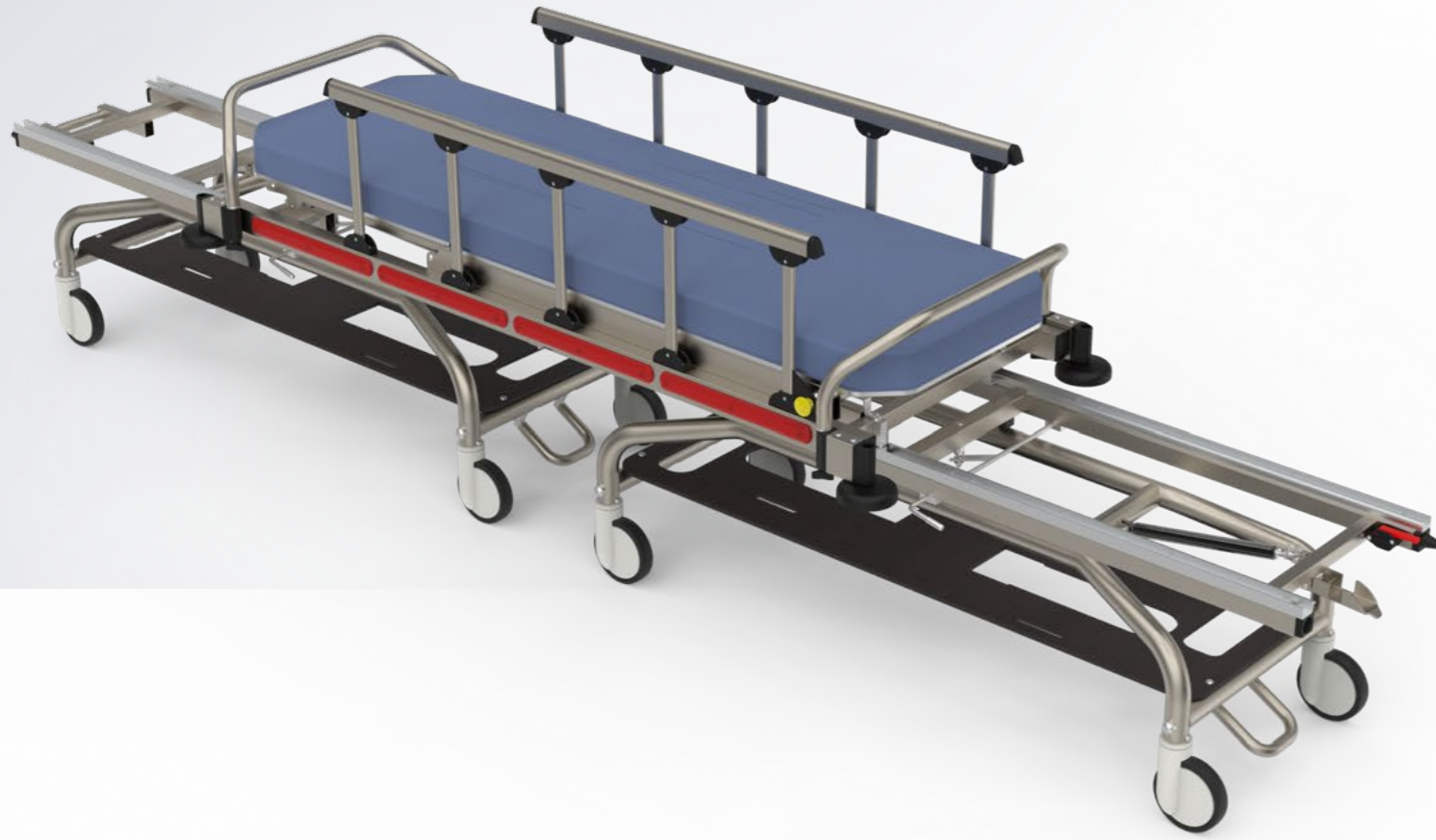

### Genel Özellikler / General Features

- Nano seramik kaplı elektrostatik toz boyalı metal aksam
- Kompak malzemeden imal 2 parçalı yatma yüzeyi
- Kolay açılıp kapanabilen metal yan korkuluklar
- Dört köşesinde serum askılığı yuvası ve çarpma tamponları
- Yüksekliği ayarlanabilir serum askısı
- Paslanmaz çelikten imal itme barları
- 360° dönebilen merkezi fren sistemli tekerler (200 mm)
- Çift emniyet kilitli transfer mekanizması
- Gazlı amortisör kontrollü trendelenburg ayarı
- Gazlı amortisör kontrollü sırt ayarı
- İki alt araba ve bir üst platform
- Oksijen tüpü taşıma yeri
- Hasta bağlama kemeri
- 60x190x8cm 28 DNS şilte
- Kolay hasta transferi
- X-ray kaset taşıyıcısı
- Nano ceramic coated electrostatic powder painted metal parts
- 2 sections lying surface made of HPL
- Easy foldable side rails made of metal
- Bumpers and IV Pole slots on 4 corners
- Height adjustable IV Pole
- Pushing bars made of stainless steel
- 360° turning casters (200 mm) with central and directional lock
- Double safety lock transfer mechanism
- Trendelenburg adjustment by gas spring
- Backrest adjustment by gas spring
- One platform on two trolleys
- Oxygen tube holder
- Patient belt
- 60x190x8cm 28 DNS mattress
- Easy patient transfer
- X-ray cassette holder

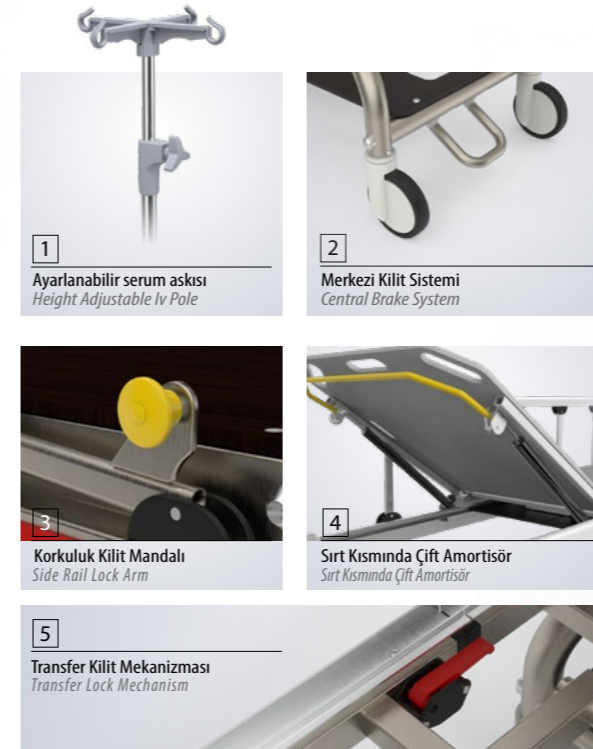

### Teknik Özellikler / Technical Features

En	Boy	Yükseklik	Yatma Yüzeyi	Sırt Açısı	Trendelenburg Açısı	Güvenli Taşıma Kapasitesi
Width	Length	Height	Lying Surface	Backrest Angle	Trendelenburg Angle	Safety Working Capacity
84 cm	208,5 cm	72 cm	60 x 193,5 cm	90°	12°	230 kg

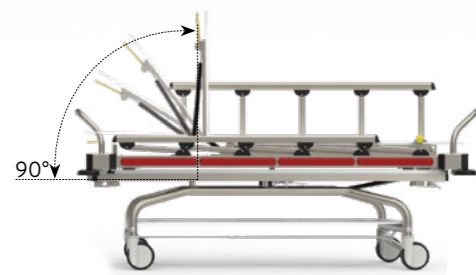

90° Sırt Hareketi  
90° Backrest Movement



12° Trendelenburg  
12° Trendelenburg



1 Ayarlanabilir serum askısı  
Height Adjustable Iv Pole



2 Korkuluk Kilit Mandalı  
Side Rail Lock Arm



3 Merkezi Kilit Sistemi  
Central Brake System

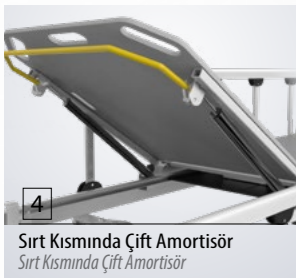

4 Sırt kısmında Çift Amortisör  
Sırt kısmında Çift Amortisör

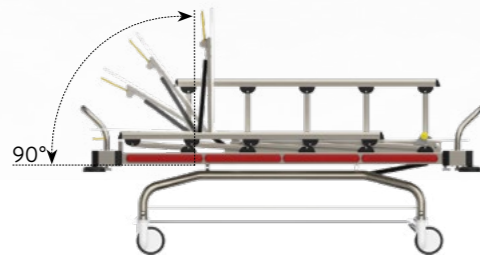

90° Sırt Hareketi  
90° Backrest Movement



12° Trendelenburg  
12° Trendelenburg

### Genel Özellikler / General Features

- Nano seramik kaplı elektrostatik toz boyalı metal aksam
- Kompak malzemeden imal 2 parçalı yatma yüzeyi
- Kolay açılıp kapanabilen metal yan korkuluklar
- Dört köşesinde serum askılığı yuvası ve çarpma tamponları
- Yüksekliği ayarlanabilir serum askısı
- Paslanmaz çelikten imal itme barları
- 360° dönebilen merkezi fren sistemli tekerler (150 mm)
- Gazlı amortisör kontrollü trendelenburg ayarı
- Gazlı amortisör kontrollü sırt ayarı
- Oksijen tüpü taşıma yeri
- Hasta bağlama kemeri
- 60x190x8cm 28 DNS şilte
- Kolay hasta transferi
- Nano ceramic coated electrostatic powder painted metal parts
- 2 sections lying surface made of HPL
- Easy foldable side rails made of metal
- Bumpers and IV Pole slots on 4 corners
- Height adjustable IV Pole
- Pushing bars made of stainless steel
- 360° turning casters (150 mm) with central lock
- Trendelenburg adjustment by gas spring
- Backrest adjustment by gas spring
- Oxygen tube holder
- Patient belt
- 60x190x8cm 28 DNS Mattress
- Easy patient transfer



### Teknik Özellikler / Technical Features

En	Boy	Yükseklik	Yatma Yüzeyi	Sırt Açısı	Trendelenburg Açısı	Güvenli Taşıma Kapasitesi
Width	Length	Height	Lying Surface	Backrest Angle	Trendelenburg Angle	Safety Working Capacity
84 cm	208,5 cm	60 cm	60 x 193,5 cm	90°	12°	230 kg

### Opsiyonel Özellikler / Optional Features

- X-ray kaset taşıyıcısı
- X-ray cassette holder



### Genel Özellikler / General Features

- Nano seramik kaplı elektrostatik toz boyalı metal aksam
- Kompak malzemeden imal tek parça yatma yüzeyi
- Kolay açılıp kapanabilen metal yan korkuluklar
- Dört köşesinde çarpma tamponları
- Elektrostatik toz boyalı imal itme barları
- 360° dönebilen merkezi fren sistemli tekerler (150 mm)
- Hidrolik kontrollü yükseklik ayarı
- Gazlı amortisör kontrollü trendelenburg ayarı
- ABS plastik kaplı alt şase
- Özel sıvı geçirmez havuz şilte
- Nano ceramic coated electrostatic powder painted metal parts
- 1 sections lying surface made of HPL
- Easy foldable side rails made of metal
- Custom liquid proof pool mattress
- Trendelenburg by gas spring
- 360° turning casters (150 mm) with central and directional lock
- ABS plastic covered lower chassis
- Hydraulically controlled height adjustment
- Bumpers on four corners
- Electrostatic powder coated pushing bars



1 Amortisör Sistemi  
Gas Spring System

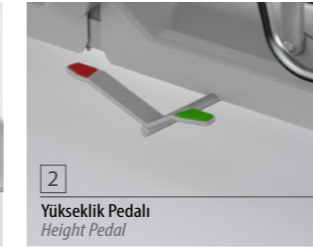

2 Yükseklik Pedalı  
Height Pedal

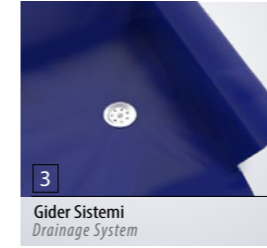

3 Gider Sistemi  
Drainage System



4 ABS Alt Şase  
ABS Plastic Bottom Chassis

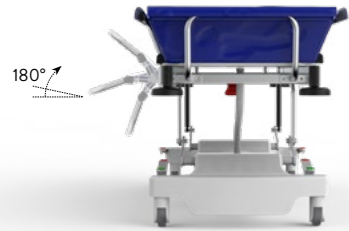
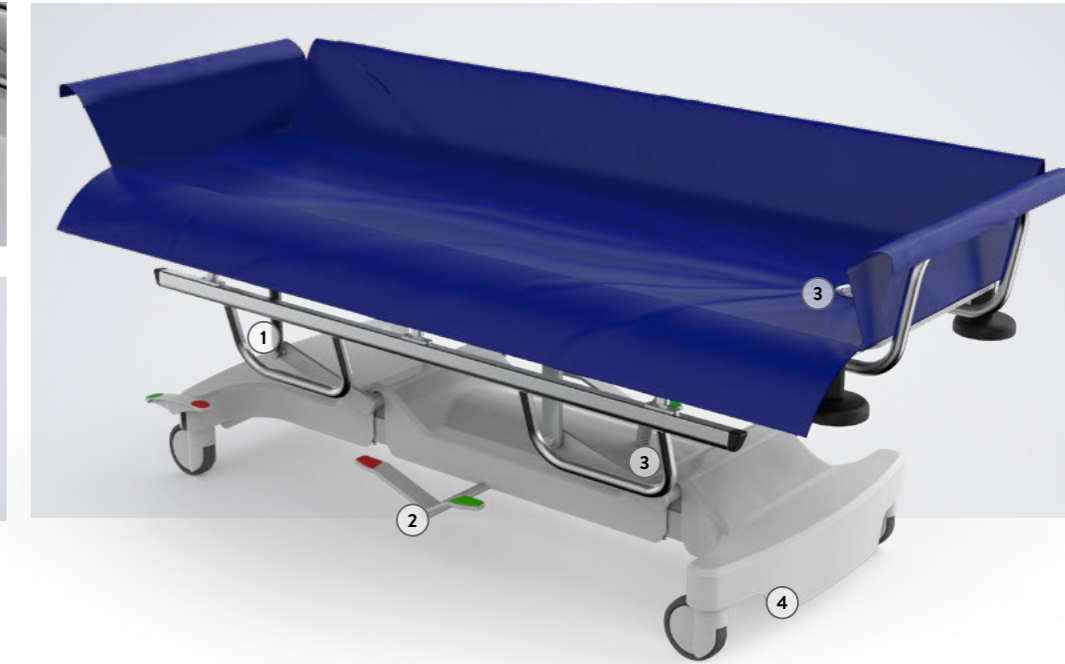

180° Açılabilen Kol  
180° Opening Side Rail System



54,5-83 cm Yükseklik Hareketi  
54,5-83 cm Height Movement



12° Trendelenburg / Ters Trendelenburg  
12° Trendelenburg/Antitrendelenburg

### Teknik Özellikler / Technical Features

En	Boy	Yükseklik Min.	Yükseklik Maks.	Yatma Yüzeyi	Trendelenburg Açısı	Güvenli Taşıma Kapasitesi
Width	Length	Height Min.	Height Max.	Lying Surface	Trendelenburg Angle	Safety Working Capacity
84 cm	208,5 cm	54,5 cm	83 cm	60 x 193,5 cm	12°	230 kg



### Genel Özellikler / General Features

- Nano seramik kaplı elektrostatik toz boyalı metal aksam
- Elektronik yükseklik ayarı
- Manuel olarak açılıp kapanabilen metal ayaklar
- El kumandası
- Şarj seviyesini gösteren kontrol paneli
- Dört noktalı yükseklik ayarlı taşıma kemeri
- Manuel CPR sistemi
- 360° dönebilen çapraz kilitli tekerler (125 mm ve 50mm)
- Nano ceramic coated electrostatic powder coated metal parts
- Electronic height adjustment
- Metal feet that can be opened and closed manually
- Hand control
- Control panel showing charge level
- Four-point height adjustable carrying belt
- Manual CPR system
- 360° rotating central locking wheels(125 mm ve 50mm)

### Teknik Özellikler / Technical Features

Uzunluk Width (Over All)	Yükseklik (Min.) Height (Min.)	Yükseklik (Maks.) Height (Max.)	Genişlik (Min.) Length (Min.)	Genişlik (Maks.) Length (Max.)	Güvenli Taşıma Kapasitesi Safety Working Capacity
130 cm	95 cm	187 cm	71 cm	96,5 cm	150 kg



Ayak Açma Hareketi  
Foot Opening Movement



95x187 cm Yükseklik Hareketi  
95x187 cm Height Movement



1  
Taşıma Kemeri  
Carrying Belt



2  
Ayak Açma Sistemi  
Foot Opening System

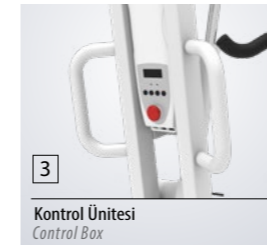

3  
Kontrol Ünitesi  
Control Box



4  
Manuel CPR Sistemi  
Manual CPR





Genel Özellikler / General Features

MA-01 / MA-02 / MA-03

- Polipropilen malzemeden imal yan paneller ve üst tabla
- Dayanıklı alüminyum malzemeden imal ana gövde
- 360° kendi etrafında dönebilen 2 adet kilitli 2 adet kilsiz teker
- Kıрма mühür sistemli merkezi kilitli çekmeceler
- ABS malzemeden imal kapaklı çöp kovası
- İç kısımları bölünebilen çekmeceler
- Çekmecelerin kolay açılıp kapanabilmesini sağlayan teleskopik raylar
- Hemşire yazı tablası
- 2 adet 445x545x70mm, 2 adet 445x545x160mm ve 1 adet 445x545x250mm ölçülerinde 5 adet çekmece.
- Opsiyonel anahtarlı kilitleme özelliği

MA-03

- 90° kendi etrafında dönebilen ayarlanabilir defibrilatör sehpası
- Teleskopik olarak ayarlanabilen serum askısı
- Polietilen malzemeden imal oksijen tüp taşıyıcısı
- Kompakt malzemeden imal resüsitasyon tahtası

MA-02

- Öne doğru devrilebilen ilaç kutuları

MA-01 / MA-02 / MA-03

- Side panels and top table made of polypropylen material
- Main frame made of durable aluminum material
- 360° rotatable 2 castors with brakes and 2 non-brake wheels
- Seal system for central locking drawers
- Disposal bin with lid made of ABS material
- Nurse writing table
- Dividable inner drawers
- Telescopic rails for easy opening and closing drawers
- 5 drawers with following dimensions:  
2 pcs 445x545x70mm,  
2 pcs 445x545x160mm,  
1 pc 445x545x250mm
- Optional Key Locking Feature

MA-03

- 90° turning defibrilator holder.
- IV Pole with telescopic adjustment
- Oxygen tube holder made of polypropylene
- CPR board made of HPL

MA-02

- Medication boxes attached on top



MA-03  
Acil Müdahale Arabası  
Emergency Trolley / Crash Cart



MA-01  
Pansuman Arabası  
Drug Trolley



MA-02  
İlaç Tedavi ve Anestesi Arabası  
Drug and Anesthesia Trolley



Teknik Özellikler / Technical Features

Model / Models	En / Width	Boy / Length	Yükseklik / Height
MA-01	82,5 cm	58,5 cm	114,5 cm
MA-02	82,5 cm	58,5 cm	157,5 cm
MA-03	82,5 cm	58,5 cm	114,5 cm



Opsiyonel / Optional



Genel Özellikler / General Features

AMC-01 / AMC-02 / AMC-03

- Polipropilen malzemeden imal yan paneller ve üst tabla
- Dayanıklı alüminyum malzemeden imal ana gövde
- 360° kendi etrafında dönebilen 2 adet kilitli 2 adet kilsiz teker
- Kıрма mühür sistemli merkezi kilitli çekmeceler
- ABS malzemeden imal kapaklı çöp kovası
- İç kısımları bölünebilen çekmeceler
- Çekmecelerin kolay açılıp kapanabilmesini sağlayan teleskopik raylar
- Hemşire yazı tablası
- 2 adet 445x545x70mm, 2 adet 445x545x160mm ve 1 adet 445x545x250mm ölçülerinde 5 adet çekmece.

AMC-03

- 90° kendi etrafında dönebilen ayarlanabilir defibrilatör sehpası
- Teleskopik olarak ayarlanabilen serum askısı
- Polietilen malzemeden imal oksijen tüp taşıyıcısı
- Kompakt malzemeden imal resüsitasyon tahtası

AMC-02

- Öne doğru devrilebilen ilaç kutuları

AMC-01 / AMC-02 / AMC-03

- Side panels and top table made of polypropylen material
- Main frame made of durable aluminum material
- 360° rotatable 2 castors with brakes and 2 non-brake wheels
- Seal system for central locking drawers
- Disposal bin with lid made of ABS material
- Nurse writing table
- Dividable inner drawers
- Telescopic rails for easy opening and closing drawers
- 5 drawers with following dimensions:  
2 pcs 445x545x70mm,  
2 pcs 445x545x160mm,  
1 pc 445x545x250mm

AMC-03

- 90° turning defibrilator holder.
- IV Pole with telescopic adjustment
- Oxygen tube holder made of polypropylene
- CPR board made of HPL

AMC-02

- Medication boxes attached on top

Teknik Özellikler / Technical Features

Model / Models	En / Width	Boy / Length	Yükseklik / Height
AMC-01	79 cm	61 cm	110 cm
AMC-02	79 cm	61 cm	155 cm
AMC-03	79 cm	61 cm	110 cm



AMC-03  
Acil Müdahale Arabası  
Emergency Trolley / Crash Cart



AMC-01  
Pansuman Arabası  
Drug Trolley



AMC-02  
İlaç Tedavi ve Anestesi Arabası  
Drug and Anesthesia Trolley





### Genel Özellikler / General Features

- Nano seramik kaplı elektrostatik toz boyalı metal aksam ve sola dönebilen ayakucu kısmı
- Sessiz çalışma için min IPX4 korumaya sahip lineer motorlar
- Ayak kumandasındaki tuşlar sayesinde elektronik olarak başucu, yükseklik ve trendelenburg pozisyonları
- Manuel olarak 90° sağa ve sola dönebilen üst şase yapısı
- Manuel olarak uzatılabilen, sağa ve sola dönebilen ayakucu kısmı
- Oturma yüzeyine paralel çalışan kol destekleri
- ABS plastik şase
- Yere sabitlenebilme özelliği
- Kesintisiz çalışma için batarya
- Poliüretan dolgulu 2 parçalı döşeme
- Nano ceramic coated electrostatic powder painted metal parts that can turn left and right
- Linear motors with min IPX4 protection for quiet operation
- Electronic backrest, height and trendelenburg positions thanks to the keys on the foot control
- Top chassis structure that can turn 90° right and left manually
- Manually extendable foot part
- Arm supports running parallel to the seating surface
- ABS plastic chassis
- Can be fixed to the ground
- Battery for continuous operation
- 2-piece upholstery with polyurethane filling

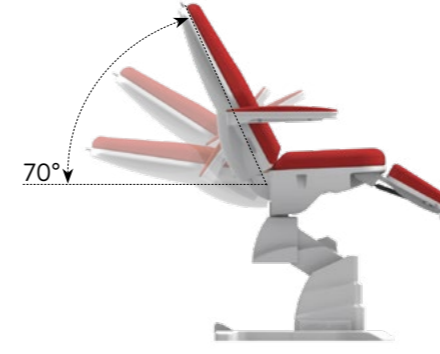

70° Sırt Hareketi  
70° Backrest Movement



30° Trendelenburg  
30° Trendelenburg

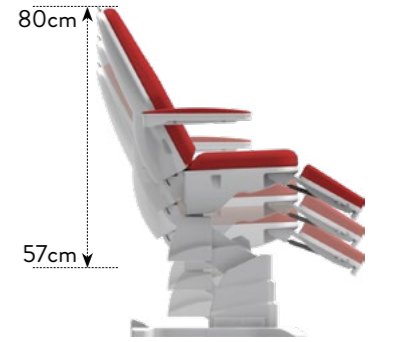

57-80cm Yükseklik Hareketi  
57-80cm Height Movement



Baldır Hareketi  
Calf Movement

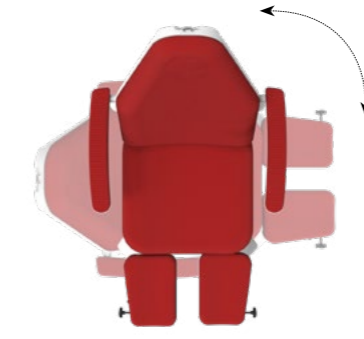

90° Sağa ve Sola Dönebilen Üst Şase  
90° Top Chassis With Right And Left Turning



### Teknik Özellikler / Technical Features

En	Boy	Yükseklik Min.	Yükseklik Max.	Sırt Yatma Yüzeyi	Oturak Yatma Yüzeyi	Sırt Açısı	Trendelenburg Açısı	Güvenli Çalışma Kapasitesi
Width	Lenght	Height Min.	Height Max.	Backrest Surface	Sitting Surface	Backrest Angle	Trendelenburg Angle	Safety Working Capacity
85 cm	168 cm	57 cm	80 cm	58x85 cm	66x51 cm	70°	30°	230 kg

### Opsiyonel Özellikler / Optional Features

- Alternatif renk seçenekleri • Alternative color options



1

Standart El Kumandası  
Standard Remote Control

2

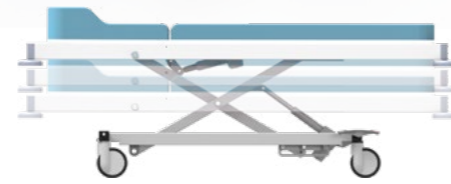
Merkezi kilit sistemi  
Central Brake System70° Sırt Hareketi  
70° Backrest Movement47-73 cm Yükseklik Hareketi  
47-73 cm Height Movement

## Genel Özellikler / General Features

- Nano seramik kaplı, elektrostatik toz boyalı metal aksam
- Kolay temizlenebilir özellikte iki parçalı yatma yüzeyi
- Elektrikli motor ile ayarlanabilen başucu ve yükseklik hareketi
- Suni deri döşeme
- Merkezi fren sistemi
- Teleskopik ayarlanabilen serum askısı
- Dört köşesinde serum askılığı yuvası ve çarpma tamponları
- Havluluk

- Nano ceramic coated, electrostatic powder painted metal parts
- Easy-to-clean two-piece lying surface
- Adjustable head and height movement with electric motor
- Artificial leather upholstery
- Central brake system
- Telescopic adjustable IV pole
- IV Pole slot and impact bumpers on four corners
- Towel holder

## Teknik Özellikler / Technical Features

En	Boy	Yükseklik Min.	Yükseklik Max.	Sırt Açısı	Yatma Yüzeyi	Güvenli Taşıma Kapasitesi
Width	Lenght	Height Min.	Height Max.	Backrest Angle	Lying Surface	Safety Working Capacity
69 cm	217 cm	47 cm	73 cm	70°	60x90 cm	230 kg



## Genel Özellikler / General Features

- Nano seramik kaplı, elektrostatik toz boyalı metal aksam
- Kolay temizlenebilir özellikte iki parçalı yatma yüzeyi
- Manuel ayarlanabilen başucu kısmı
- Suni deri döşeme
- Katlanır ayak mekanizması
- Havluluk
- Yüksekliği ayarlanabilir serum askısı

- Nano ceramic coated, electrostatic powder painted metal parts
- Easily cleanable two-piece lying surface
- Manually adjustable headrest
- Faux leather upholstery
- Foldable foot mechanism
- Towel holder
- Height adjustable IV Pole

## Teknik Özellikler / Technical Features

En	Boy	Yükseklik
Width	Lenght	Height
65 cm	190 cm	79 cm





#### Genel Özellikler / General Features

- Nano seramik kaplı, elektrostatik toz boyalı metal aksam
- Ahşap malzemeden imal edilmiş, temizlenebilir gövde
- Kolay temizlenebilir özellikte iki parçalı yatma yüzeyi
- Manuel ayarlanabilen başucu kısmı
- Suni deri döşeme
- Şase kısmı demonte edilebilir özelliktedir
- 2 adet teleskopik raylı çekmece
- Havluluk

- Nano ceramic coated electrostatic powder painted metal parts
- Frame covered by easy clean wooden.
- Lying surface with 2 sections
- Manual adjustment of back rest
- Faux leather covering
- The frame can be disassembled
- 2 drawers with telescopic rails
- Towel holder

#### Teknik Özellikler / Technical Features

En	Boy	Yükseklik
Width	Length	Height
68 cm	190 cm	82 cm



#### Genel Özellikler / General Features

- Suntalam malzemeden imal gövde yapısı
- Çift kapaklı, rafli dolap
- Abs malzemeden imal küvez
- 28Dns şilte
- 0-100cm ayarlı boy ölçüm cetveli
- 10gr hassasiyetli 30 kg'a kadar tartı sistemi
- Dijital gösterge
- Batarya
- Kolay taşınabilir 2 adet teker ve 2 adet sabitleme ayağı

- Body structure made of chipboard
- Double door cabinet with shelves
- Incubator made of ABS material
- 28 density mattress
- 0-100cm adjustable height measuring ruler
- Weighing system with 10 gr precision up to 30 kg
- Digital indicator
- Battery
- Easily portable 2 wheels and 2 fixing feet

#### Teknik Özellikler / Technical Features

En	Boy	Yükseklik
Width	Length	Height
55 cm	108 cm	120,5 cm





### Genel Özellikler / General Features

- Nano seramik kaplı elektrostatik toz boyalı metal aksam
- Sessiz çalışma için min IPX4 korumaya sahip lineer motorlar
- El kumandası
- Elektronik olarak başucu ve ayakucu hareketleri
- Oturma yüzeyine paralel çalışan kol destekleri
- ABS plastik şase
- 360° dönebilen çapraz kilitli tekerler (125 mm)
- Poliüretan dolgulu 3 parçalı döşeme
- Nano ceramic coated electrostatic powder painted metal parts
- Minimum IPX 4 protection liner motors for silent operation
- Arm supports working parallel to the floor
- ABS plastic chassis
- 360° Swivel cross lock castors (125 mm)
- Three-piece upholstery with poliurethan filling
- Electronic backrest and Foot movements
- Remote Control

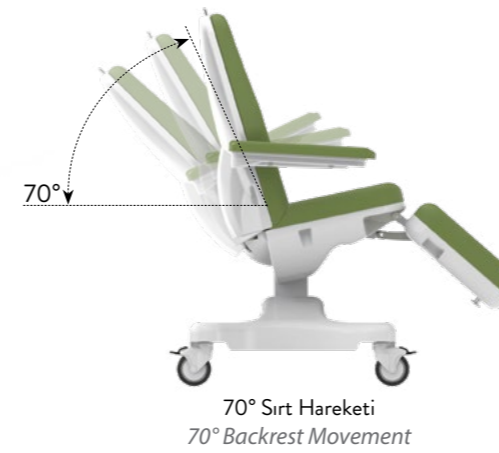

### Teknik Özellikler / Technical Features

En	Boy	Yükseklik	Sırt Yatma Yüzeyi	Oturak Yatma Yüzeyi	Sırt Açısı	Ayak Açısı	Güvenli Çalışma Kapasitesi
Width	Lenght	Height	Backrest Surface	Sitting Surface	Backrest Angle	Trendelenburg Angle	Safety Working Capacity
95 cm	185 cm	72 cm	60x80 cm	60x50 cm	70°	80°	230 kg

### Opsiyonel Özellikler / Optional Features

- Alternatif renk seçenekleri
- Ayak basma aparatı
- Batarya
- Alternative color options
- Battery
- Foot pressing



Standart El Kumandası  
Standard Remote Control

### Genel Özellikler / General Features

- Nano seramik kaplı elektrostatik toz boyalı metal aksam
- Sessiz çalışma için min IPX4 korumaya sahip lineer motorlar
- El kumandası
- Elektronik olarak başucu, yükseklik ve ayakcu hareketleri
- Oturma yüzeyine paralel çalışan kol destekleri
- ABS plastik şase
- Poliüretan dolgulu 3 parçalı döşeme
- Nano ceramic coated electrostatic powder painted metal parts
- Minimum ipx4 protection lineer motors for silent operation
- Remote control
- Electronically controlled backrest, legrest and height movements
- Arm supports working parallel to the floor
- Abs plastic chassis
- Three-piece upholstery with poliurethan filling



70° Sırt Hareketi  
70° Backrest Movement



80° Ayak Hareketi  
80° Legrest Movement



67-93cm Yükseklik Hareketi  
67-93cm Height Movement



### Teknik Özellikler / Technical Features

En	Boy	Yükseklik Mim.	Yükseklik Max.	Sırt Yatma Yüzeyi	Oturak Yatma Yüzeyi	Sırt Açısı	Ayak Açısı	Güvenli Çalışma Kapasitesi
Width	Lenght	Height Min.	Height Max.	Backrest Surface	Sitting Surface	Backrest Angle	Trendelenburg Angle	Safety Working Capacity
95 cm	185 cm	67 cm	93 cm	60x80 cm	60x50 cm	70°	80°	230 kg

### Opsiyonel Özellikler / Optional Features

- Alternatif renk seçenekleri
- Batarya
- Alternative color options
- Battery



Yemek Tablası Yükseklik Hareti  
Dining Table Height Movement

Yemek Tablası Tilt Hareti  
Dining Table Tilt Movement

### Genel Özellikler / General Features

- Sıvı dökülmesine karşı yükseltilmiş tabla
- HPL malzemeden imal kapaklar
- Şase bağlantısını destekleyen alüminyum sütunlar
- HPL malzemeden imal şase yapısı
- Teleskopik raylı çekmece
- Kolay temizlenebilir ve çıkarılabilen ABS plastik çekmece hazneleri
- 360° dönebilen çapraz kilitli tekerler
- Monoblok alüminyum katlanabilir yemek masası
- Amortisör kontrollü yükseklik ayarlı yemek masası
- Yemek masasında kitap okuma pozisyonu için tilt hareketi
- Eşya koymak için ara bölme
- Yemek masası kenarlarında alüminyum malzemeden imal yükselticiler

- Raised table against liquid spillage
- Covers made of HPL material
- Aluminium columns supporting frame connections
- Chassis structure made of HPL material
- Telescopic drawer rails
- Detachable, easy to clean ABS Plastic drawer box
- 360° swivel cross lock castors
- Monoblock aluminum foldable dining table
- Shock absorber controlled height adjustable dining table
- Tilt movement for the reading position on the dining table
- Partition for stuff storage
- Risers made of aluminum material on the edges of the dining table

### Teknik Özellikler / Technical Features

En	Boy	Yükseklik	Yemek Masası Tablası En	Yemek Masası Tablası Boy	Yemek Masası Yüksekliği Min.	Yemek Masası Yüksekliği Max.
Width	Lenght	Height	Bed Table Width	Bed Table Lenght	Bed Table Height Min.	Bed Table Height Max.
63 cm	47 cm	88,5 cm	40 cm	58 cm	84 cm	112 cm

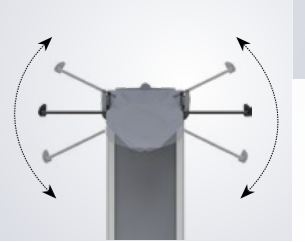
Yemek Tablası Yükseklik Hareti  
Dining Table Height MovementYemek Tablası Tilt Hareti  
Dining Table Tilt Movement

## Genel Özellikler / General Features

- Kompakt malzemeden imal üst tabla ve ön kapaklar
- Şase bağlantısını destekleyen alüminyum sütunlar
- Metal kasa
- Teleskopik raylı çekmece
- 360° dönebilen çapraz kilitleli tekerler
- Alüminyum katlanabilir yemek masası
- Amortisör kontrollü yükseklik ayarlı yemek masası
- Eşya koymak için ara bölme
- Kolay temizlenebilir ve çıkarılabilir ABS plastik çekmece hazneleri
- Her iki tarafında uyumlu sökülüp takılabilen yemek masası
- Yemek masasında kitap okuma pozisyonu için tilt hareketi
- Elektrostatik toz boyalı metal aksam
- Yemek masası kenarlarında alüminyum malzemeden imal yükseltler

- Top table and front covers made of HPL
- Aluminium columns supporting frame connections
- Metal main frame
- Telescopic drawer rails
- 360° swivel cross lock castors
- Aluminum foldable dining table
- Shock absorber controlled height adjustable dining table
- Partition for stuff storage
- Easy to clean and removable ABS plastic drawer containers
- Easily removable dining table with possibility to be attached on both sides
- Tilt movement for the reading position on the dining table
- Electrostatic powder painted metal parts
- Risers made of aluminum material on the edges of the dining table

## Teknik Özellikler / Technical Features

En	Boy	Yükseklik	Yemek Masası Tablası En	Yemek Masası Tablası Boy	Yemek Masası Yüksekliği Min.	Yemek Masası Yüksekliği Max.
Width	Lenght	Height	Bed Table Width	Bed Table Lenght	Bed Table Height Min.	Bed Table Height Max.
59 cm	44,5 cm	86 cm	40 cm	58 cm	84 cm	112 cm



Yemek Tablası Yükseklik Hareti  
Dining Table Height Movement

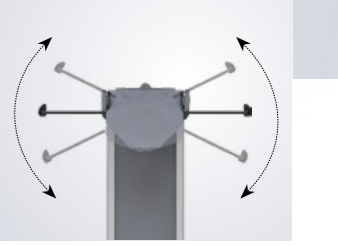

Yemek Tablası Tilt Hareti  
Dining Table Tilt Movement

### Genel Özellikler / General Features

- Kompakt malzemeden imal üst tabla ve ön kapaklar
- Şase bağlantısını destekleyen alüminyum sütunlar
- HPL malzemeden imal gövde yapısı
- Teleskopik raylı çekmece
- 360° dönebilen çapraz kilitli tekerler
- Alüminyum katlanabilir yemek masası
- Amortisör kontrollü yükseklik ayarlı yemek masası
- Eşya koymak için ara bölme
- HPL malzemeden imal Zadet çekmece
- Yemek masasında kitap okuma pozisyonu için tilt hareketi
- Yemek masası kenarlarında alüminyum malzemeden imal yükselticiler
- Top table and front covers made of HPL
- Aluminium columns supporting frame connections
- Main frame made of HPL
- Telescopic drawer rails
- 360° swivel cross lock castors
- Aluminum foldable dining table
- Shock absorber controlled height adjustable dining table
- Partition for stuff storage
- 2 drawers made of HPL
- Tilt movement for the reading position on the dining table
- Risers made of aluminum material on the edges of the dining table

### Teknik Özellikler / Technical Features

En	Boy	Yükseklik	Yemek Masası Tablası En	Yemek Masası Tablası Boy	Yemek Masası Yüksekliği Min.	Yemek Masası Yüksekliği Max.
Width	Lenght	Height	Bed Table Width	Bed Table Lenght	Bed Table Height Min.	Bed Table Height Max.
65 cm	45 cm	87 cm	40 cm	58 cm	84 cm	112 cm





### Genel Özellikler / General Features

- HPL malzemeden imal gövde yapısı
- Şase bağlantısını destekleyen alüminyum sütunlar
- HPL malzemeden imal 2 adet çekmece
- Çift tarafında katlanabilir yemek masası
- Yemek masalarında kapanırken darbe emici mekanizma
- 360° dönebilen çapraz kilitli tekerler
- Eşya koymak için ara bölme
- Tek elle çıkartılabilir ergonomik çekmece sistemi
- Yemek masası kenarlarında paslanmaz malzemeden imal yükselticiler

- Main frame made of HPL
- Aluminium columns supporting frame connections
- 2 drawers made of HPL
- Foldable dining table on double side
- Shock absorbing mechanism while closing on dining table
- 360° swivel cross lock castors
- Partition for stuff storage
- Removable ergonomic drawer system with one hand
- Risers made of stainless material on the edges of the dining table

### Teknik Özellikler / Technical Features

En	Boy	Yükseklik	Yemek Masası Tablası En	Yemek Masası Tablası Boy	Yemek Masası Yüksekliği
Width	Lenght	Height	Bed Table Width	Bed Table Lenght	Bed Table Height
61,5 cm	45,5 cm	93 cm	33,5 cm	54,5 cm	88 cm

### Genel Özellikler / General Features

- Suntalam malzemeden imal gövde yapısı
- Tek elle çıkartılabilir ergonomik çekmece sistemi
- 360° dönebilen çapraz kilitli tekerler
- Suntalam malzemeden imal 1 adet çekmece ve dolap
- Eşya koymak için bir adet ara bölme
- Ayakkabı koymak için bir adet ara bölme

- Main structure made of chipboard
- Removable ergonomic drawer system with one hand
- 360° swivel castors with cross lock
- 1 drawer and cabinet made of chipboard
- One partition for stuff storage
- One partition for shoes storage

### Teknik Özellikler / Technical Features

En	Boy	Yükseklik
Width	Lenght	Height
42 cm	40 cm	87 cm



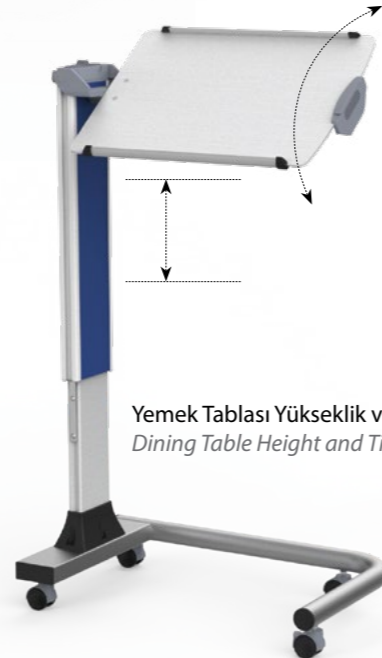

Yemek Tablası Yükseklik ve Tilt Hareti  
Dining Table Height and Tilt Movement

#### Genel Özellikler / General Features

- Nano seramik kaplı, elektrostatik toz boyalı metal aksam
- 360° dönebilen çapraz kilitli tekerler
- Yer tasarrufu için katlanabilir yapı
- Amortisör kontrollü yükseklik ayarı
- Alternatif renkli etiket seçenekleri
- HPL malzemeden imal üst tabla
- Alüminyum kolon sistemi

- Nano ceramic coated, electrostatic powder painted metal parts
- 360° rotating wheels with cross lock
- Foldable structure for space saving
- Shock absorber controlled height adjustment
- Alternative color label options
- Top plate made of HPL material
- Aluminum column system

#### Teknik Özellikler / Technical Features

En	Boy	Yükseklik Min.	Yükseklik Max.	Üst Tabla En	Üst Tabla Boy
Width	Lenght	Height Min.	Height Max.	Bed Table Width	Bed Table Lenght
44 cm	73 cm	84 cm	113 cm	40 cm	58,5 cm



#### Genel Özellikler / General Features

- Kompakt laminant üst tabla
- 360° dönebilen çapraz kilitli tekerler
- Nano seramik kaplı, elektrostatik toz boyalı metal aksam
- Amortisör kontrollü yükseklik ayarı

- Compact laminate top
- 360° swivel cross lock castors
- Nano ceramic coated electrostatic powder painted metal parts
- Shock absorber controlled height adjustment

#### Opsiyonel Özellikler / Optional Features

ABS plastik üst tabla ABS top table



#### Teknik Özellikler / Technical Features

En	Boy	Yükseklik Min.	Yükseklik Max.	Üst Tabla En	Üst Tabla Boy
Width	Lenght	Height Min.	Height Max.	Bed Table Width	Bed Table Lenght
44,5 cm	83,5 cm	81,5 cm	116 cm	40 cm	73 cm



### Genel Özellikler / General Features

- Paslanmaz çelik malzemeden imal gövde yapısı
- İç içe geçen tasarımı ile yer tasarrufu
- Hareketli yapıya sahip, katlanabilir ayak koyma yeri
- 360° dönebilen tekerlekler
- Arka tekerlerde merkezi fren sistemi

- İdrar torbası askılığı
- Emniyet kemeri
- Yüksekliği ayarlanabilir paslanmaz çelik malzemeden imal serum askısı
- Geriye katlanabilir kol destekleri
- En: 68 cm
- Boy: 89,5 cm
- Yükseklik: 99 cm

- Body structure made of stainless steel material
- Space saving with its interlocking design
- Foldable foot rest with movable structure
- 360° rotating wheels
- Central brake system on rear wheels

- Urine bag holder
- Safety belt
- IV Pole made of stainless steel height adjustable
- Retractable arm rests
- Width: 68 cm
- Length: 89.5 cm
- Height: 99cm

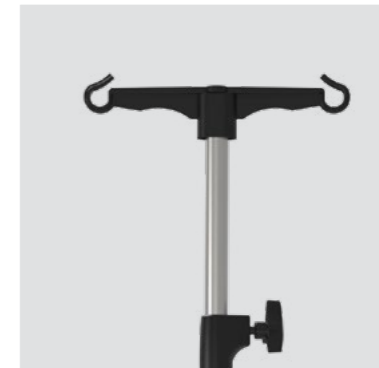



**Genel Özellikler / General Features**

- Elektro statik toz boyalı metal aksam
- 2 Frenli 2 frensiz teker
- Amortisör yardımı ile yükseklik ayarlama özelliği
- Pleksiglass küvez
- 30x60x5 cm şilte

- Nano ceramic coated electrostatic powder painted metal parts
- Two castors with brake and two without
- Height adjustment feature with damper assist
- Plexiglass cradle
- 30x60x5 cm mattress

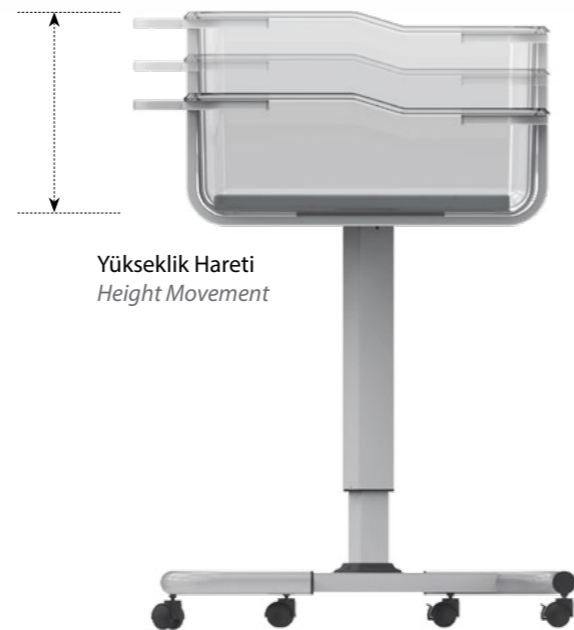

**Teknik Özellikler / Technical Features**

En	Boy	Yükseklik Min.	Yükseklik Max.
Width	Length	Height Min.	Height Max.
48,5 cm	90 cm	92 cm	126 cm

**Genel Özellikler / General Features**

- Paslanmaz çelik metal aksam
- Manuel yükseklik ayarı
- Dört kancalı paslanmaz askılık
- Beş adet tekerlek ile kolay hareket sistemi
- 120-200cm yükseklik ayarı

- Stainless steel metal parts
- Manual height adjustment
- Stainless steel hanger with four hooks
- Easy movement system with five wheels
- 120-200cm height adjustment

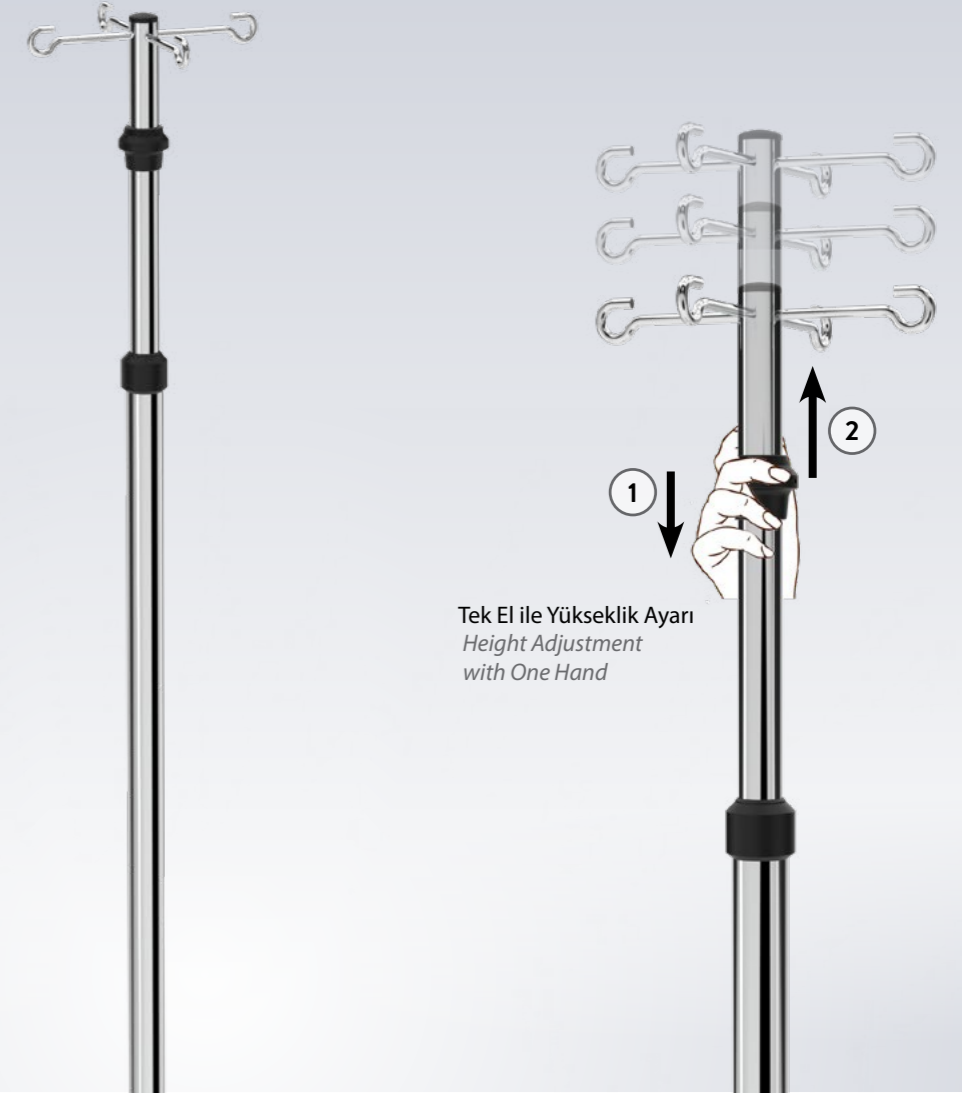

Tek El ile Yükseklik Ayarı  
Height Adjustment  
with One Hand



## S-01 Anti Bakteriyel Şilte Anti Bacterial Mattress

### Genel Özellikler / General Features

- Terletmeyen özellik
- Poliüretan esaslı anti bakteriyel kılıf
- Sıvı, kan v.b. geçirmez
- 28 DNS yoğunluk
- Ateşe dayanıklı
- Antiperspirant feature
- Polyurethane based anti-bacterial sheath
- Liquid, blood, etc. proof
- 28 DNS density
- Fireproof

### Teknik Özellikler / Technical Features

En	Boy	Yükseklik
Width	Lenght	Height
85 cm	190 cm	12 cm

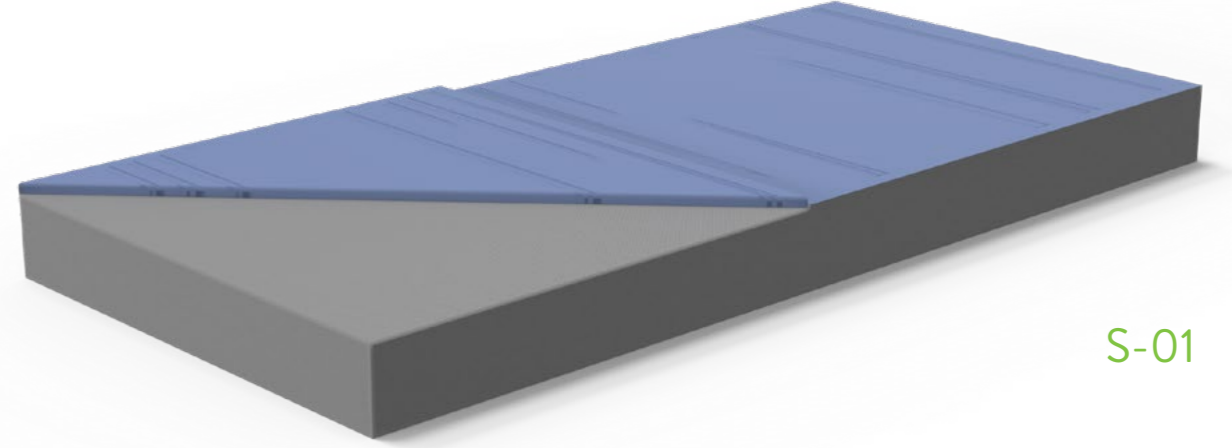

S-01

## S-02 Anti Bakteriyel Şilte Anti Bacterial Mattress

### Genel Özellikler / General Features

- Terletmeyen özellik
- Poliüretan esaslı anti bakteriyel kılıf
- Sıvı, kan v.b. geçirmez
- 28 DNS yoğunluk
- Ateşe dayanıklı
- Cnc kanallı
- Antiperspirant feature
- Polyurethane based anti-bacterial sheath
- Liquid, blood, etc. proof
- 28 DNS density
- Fireproof
- CNC channel

### Teknik Özellikler / Technical Features

En	Boy	Yükseklik
Width	Lenght	Height
85 cm	190 cm	12 cm

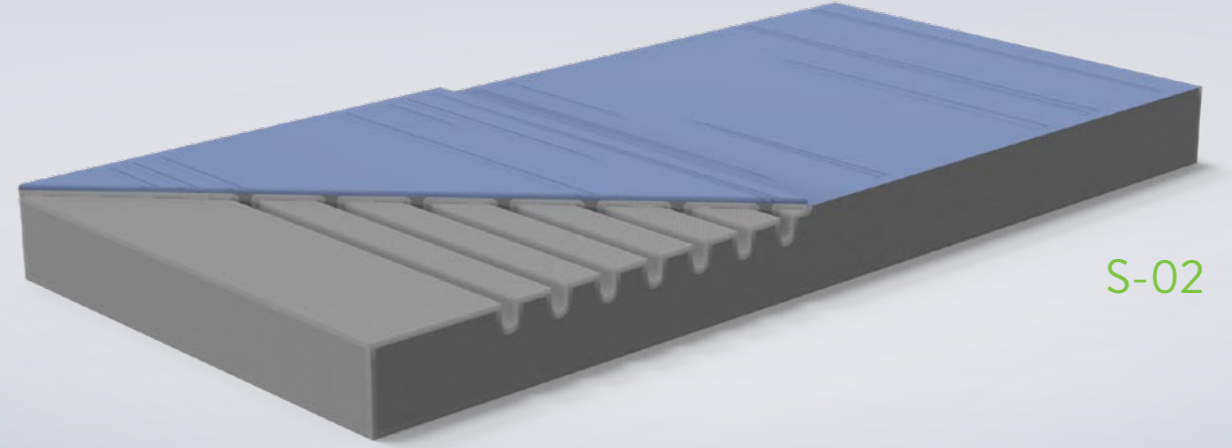

S-02

## S-03 Anti Bakteriyel Visco Şilte Anti Bacterial Visco Mattress

### Genel Özellikler / General Features

- Terletmeyen özellik
- Poliüretan esaslı anti bakteriyel kılıf
- Sıvı, kan v.b. geçirmez
- Yüksek yoğunluklu 2 parçalı sünger
- Ateşe dayanıklı
- Cnc kanallı
- Antiperspirant feature
- Polyurethane based anti-bacterial sheath
- Liquid, blood, etc. proof
- 28 DNS density
- Fireproof
- CNC channel

### Teknik Özellikler / Technical Features

En	Boy	Yükseklik
Width	Lenght	Height
85 cm	190 cm	12 cm

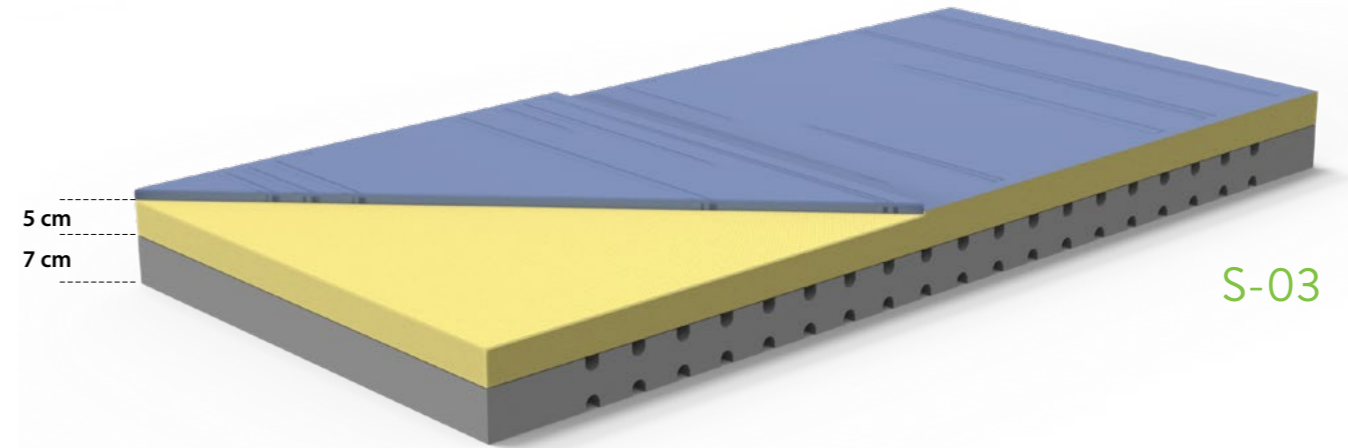

S-03

# AC-02 Refakatçi Koltuğu Caregiver Chair



## Genel Özellikler / General Features

- 1,5 mm kalınlığında profilden yapılmış çerçeve
- 28 DNS Sünder
- Dekoratif görünüm
- 75 mm çapında 2 adet frenli 4 adet teker
- Suni deri
- Ahşap kol dayama
- Frame made of profile with 1,5mm thickness
- Foam with 28 density
- Decorative appearance
- 4 casters with 75mm diameter, 2 of them with brake
- Coated by faux leather
- Wooden armrest

## Teknik Özellikler / Technical Features

En	Boy	Yükseklik Min.	Yatma Yüzeyi
Width	Lenght	Height Min.	Lying Surface
80 cm	106 cm	86 cm	190x60 cm

